



designed to be different

# CELEBRATING WARMTH

GAS FIRES 2020/2021





## CONTENTS

### *Experience the most beautiful fire*

*With every fire we design, we ask ourselves: "what role does a fire play in the lives of our customers?" Our fires prove every day that we look beyond high reliability. Every detail, no matter how small, contributes to an optimal combination of function, atmosphere, durability and comfort. In short, the most beautiful fire.*

#### OPTIONS AND POSSIBILITIES

• The selection steps	4
• Tailor-made atmosphere and warmth	6
• Your ideal flame image	8
• Burner bed and interior finish	10
• Door systems and glass	12

#### TECHNICAL SPECIFICATIONS

• Attachments and accessories	82
• Framed or frameless	85
• Placement options	86
• Technical drawings	90
• Technical specifications	96

#### DRU FIRES PRODUCT RANGE

• DRU <b>3-sided fires</b>	16
• DRU <b>2-sided fires</b>	27
• DRU <b>Front fires</b>	34
• DRU <b>Tunnel fires</b>	48
• DRU <b>Freestanding fires</b>	58

#### GLOBAL BY DRU PRODUCT RANGE

<b>Open combustion (CF)</b>	
• Global <b>Front fires</b>	68
<b>Closed combustion (BF)</b>	
• Global <b>3-sided fires</b>	71
• Global <b>2-sided fires</b>	74
• Global <b>Front fires</b>	76



#### See our fires burn

Scan the QR codes by the fireplaces and see how each fire burns.



# WHICH GAS FIRE SUITS YOU?

*You want a gas fire. A good idea, because it not only provides warmth and comfort, but also atmosphere and cosiness in your home.  
Which gas fire is best suited for your home?*



## *Atmosphere and warmth in your home*

Would you like a new fire for the warmth or do you prefer the atmosphere? The motivation behind your wish determines the first step on the way to your new gas fire.

## *Design for everyone*

Do you like a classic design or do you prefer a sleek and modern one? At DRU you will find gas fires for every taste and every room. From built-in to freestanding fires, from 1-sided to 3-sided flame view or even with a view through like a tunnel. You choose!

## *Space and efficiency*

The capacity of the gas fire depends on the room where it will be placed, how well your house is insulated and the use of the fire: do you turn it on every day or only on weekends, for example? Knowing this means you always choose the most sustainable solution for your needs.

## *Visit a dealer*

At an authorised DRU dealer in your area you can get tailored advice and take a closer look at our models. This way, you can make a well-considered choice for a fire you'll enjoy for years to come.



## TAILORED ATMOSPHERE AND WARMTH

*Is a gas fire just for autumn and winter? No, it's not! In spring and summer you can enjoy the cosy feeling and an atmospheric flame image, even without the accompanying heat.*



### ECO WAVE:

*always a lively fire and warmth to your liking*

If you choose a fire with Eco Wave, you can design the pattern of the flame intensity, which can be very economical. This is ideal if you want the atmosphere and a beautiful flame pattern, but not the heat. You can switch it on with the remote control, or with the smart app you can control everything yourself.



### ECO GLOW:

*100% atmosphere, 0% heat*

Do you like to look at a lit fire, but don't always need the warmth that comes with it? Many of our fires have an optional glow bed: Eco Glow. This lifelike glow bed is separately adjustable, independently of the flames. You determine the atmosphere via the app or with the remote control, with or without heat from the fire.





# CREATE A PERSONAL FLAME PATTERN

*With our unique burner technology, you choose the flame pattern  
that suits your taste:*



## DYNAMIC FLAME BURNER®

- Lively, natural flames
- Burner 1: for width and depth in the fire
- Burner 2 (switch off): gives the flames volume and height



## VARIO BURNER

- A rich flame image with lots of depth
- The experience of wood fire: wide and high flames
- Multiple dimensions due to the unique Zigzag shape



## TRUFLAME BURNER®

- Perfect flame image
- Gives the illusion of a high and natural wood fire
- Burners at an upward angle, integrated in the ceramic logs



## LINE BURNER

- High flames in a nice clean line
- Flames across the entire width of the fireplace
- Unique, dynamic and sleek flame image





# WHAT LOOK SHOULD YOUR GAS FIRE HAVE?

*Tastes differ, even when it comes to a gas fire. At DRU you put together your favourite fire, down to the smallest details. You can choose different burner beds and options for the internal lining for part of our range of fireplaces.*



Brown log set

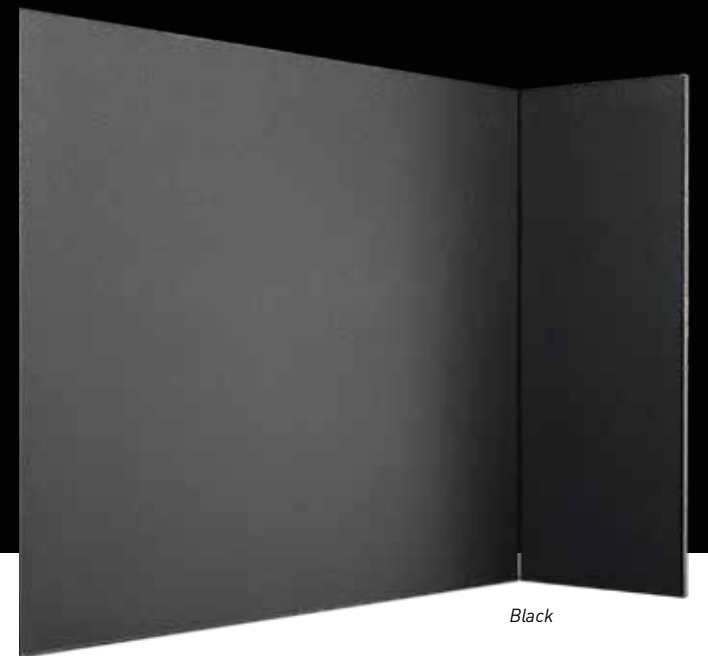

Black

## BURNER BED

- Log set brown or white (birch): indistinguishable from the real thing due to structure and colour
- Anthracite glass: the reflection of the fire provides even more depth
- White or grey stones

*Available on a part of the assortment.*



White log set



Anthracite glass



White stones



Grey stones

## INTERIOR FINISH

- Black: sleek design and ideal in combination with Clear View glass
- Ceraglass: A mirror effect creates extra depth in your fire.
- Natural: light yellow wall with fine profiling
- Classic stone: a classic or country look, like the old brick fireplaces.

*Available on a part of the assortment.*

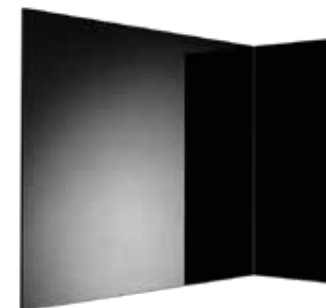

Ceraglass



Natural



Classic stone (DRU)



Classic stone (Global by DRU)



# OPTIMAL VIEW OF THE FLAMES



## EASY RELEASE DOOR SYSTEM

*Cleaning in a jiffy*

We provide several gas fires with a drop down or side opening door. Easy to open without expertise and ideal for quick window cleaning and annual maintenance by an engineer.

- Can be opened directly without screws or expertise
- Subtly concealed lever
- Discreet frames for more glass surface and uninterrupted flame vision
- Neat glass-on-glass for 2 and 3-sided models
- Room sealed: safe and optimal combustion

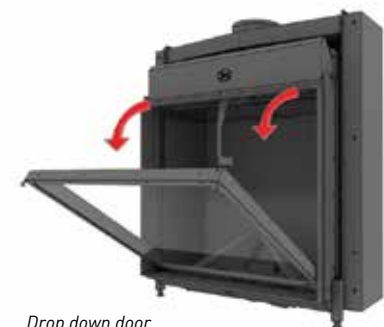

Drop down door



Side opening door

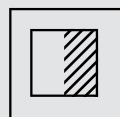

## CLEAR VIEW GLASS

*Anti-reflective glass*

A good view of the flames means extra enjoyment of your burning gas fire. That's why DRU offers you Clear View Glass\*: anti-reflective glass that gives you an optimum view of the fire. Transparent and so clear that it looks as if there is no glass at all.

\* Available on virtually the entire range.



# FIREPLACES FOR EACH TYPE OF GAS

*When designing our energy-efficient fires and stoves, we not only look at the design, but also ensure that all our products can be used as widely as possible.*

### Fixed connection or with bottled gas, anything is possible.

Even if you don't have a fixed gas connection with natural gas, that's no problem at all! With propane or butane gas, the gas is fed from a gas bottle to the gas fire. This way you can continue to enjoy the warmth and atmosphere of a gas fire even without natural gas.

### Choose biogas, the environmentally friendly alternative

In addition to natural gas, propane and butane, almost all our gas fires are suitable for biogas. This is a renewable gas that is generated in a sustainable manner and is a green replacement for natural gas.



All our gas fires are equipped with the VBS system. This ensures that our fires always burn despite the different compositions of the different gas types. You can be assured of warmth and cosiness for years to come!





designed to be different

# THE DRU PRODUCT RANGE

*Fantastic quality and plenty of choice.  
DRU fires offer a perfect solution for every  
situation and every type of home interior.  
All the fires in our large product range  
meet the strictest requirements in quality,  
performance, durability and convenience.  
From the perspective of design and  
innovation, the DRU product range is unique.*



Eco Wave  
[P. 7]

Eco Wave gives you total control over the heat output while retaining a lovely flame pattern of your choice.



Eco Glow  
[P. 7]

Real life illuminated glow bed. Individually adjustable via app or remote control. With or without heat from the fire.



Dynamic Flame Burner®  
[P. 8]

Dynamic Flame Burner® gives you the feeling of a natural wood fire, but with the convenience of gas.



Vario Burner  
[P. 9]

The Vario Burner provides depth and width to the flames of your fire.



Line Burner  
[P. 9]

The Line Burner provides a lovely tight flame pattern over the width of the fire.



Easy release door system  
[P. 12]

The Easy release door system is a unique drop down or side opening door that lets you easily clean and maintain



Clear View glass  
[P. 12]

No bothersome reflections; always a clear view of the fire.



Safety Control System (Dutch: VBS)  
[P. 13]

These fires are completely suitable for various types of gasses and fully prepared for the future.



Domotica Home Automation  
[P. 82]

Possibility to connect to home automation systems for smart control in the home.



App Control  
[P. 82]

All DRU Eco Wave fires can be operated via smartphone or tablet with the free DRU Control App (IOS or Android).



Frames  
[P. 85]

Frameless installation or optional frames (customisation possible).



PowerVent®  
[P. 86]

PowerVent® gives you the freedom to install an attractive gas fire regardless of the available space.



Direct flue  
[P. 87]

Directly on the fire via a 90° pipe bend to the outside.



3-Sided fires XTU  
[P. 16]



3-Sided fires  
[P. 19]



3-Sided fires XTL  
[P. 26]



2-Sided fires  
[P. 27]



Front fires  
[P. 34]



Tunnel fires  
[P. 48]



Freestanding fires  
[P. 58]



## MAESTRO 75XTU ECO WAVE

Stylish and versatile gas fire.



The Maestro 75XTU with a view of the fire on 3 sides allows you to enjoy the pleasant atmosphere and warmth from several areas. Very suitable for placing in a corner, for example in an L-shaped living room.

### Characteristics:

- High windows, a lovely large view of the fire
- Wide output range
- Can be built in tightly and without a frame
- Custom-made frame available

### Choose your own size:

[For precise dimensions, see p.90]



75XTU

### Maestro 75XTU Eco Wave



### Output range

Natural gas G20 **1.2 - 8.8 kW**  
 Natural gas G25.3 **1.2 - 8.4 kW**  
 Propange G31 **1.9 - 9.5 kW**

### Efficiency

**93.3%**



Scan this QR code for burning fire.

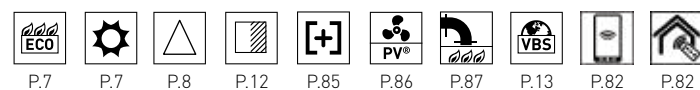



## METRO 100XTU ECO WAVE

Beautiful room divider gas fire.

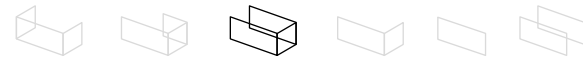

Scan this QR code for burning fire.

## MAESTRO 60/3 ECO WAVE

For an all year round fireplace experience.



Scan this QR code for burning fire.

The Metro 100XTU is the ideal fire if you are looking for a room divider or a fire that allows you to enjoy the flames from several corners of your living space.

### Characteristics:

- Suitable for installation in a corner
- Also suited for partially suspended or semi-high built-in
- Various interior finishes available
- Various fire beds available

### Choose your own size:

(For precise dimensions, see p.90)



100XTU



Metro 100XTU Eco Wave

<b>Output range</b>	
Natural gas G20	<b>4.3 - 9.6 kW</b>
Natural gas G25.3	<b>3.3 - 9.0 kW</b>
Propane G31	<b>4.1 - 9.1 kW</b>

**Efficiency**  
83.3%

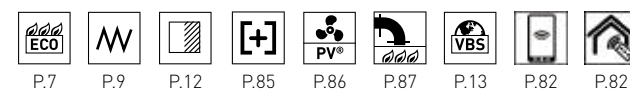

The new 3-sided gas fire has extra tall windows for a perfect view of the beautiful flames. Besides it has the unique, new Eco Glow feature for all year round function, atmosphere, warmth and comfort.

### Characteristics:

- Extra tall panoramic windows for a stunning fire view
- Optional Clear View (anti-reflective) glass
- Can be built in tightly and without a frame

### Choose your own size:

(For precise dimensions, see p.90)



60/3

80/3

105/3



Maestro 60/3 Eco Wave

<b>Output range</b>	
Natural gas G20	<b>1.9 - 7.2 kW</b>
Natural gas G25.3	<b>1.6 - 6.8 kW</b>
Propane G31	<b>1.1 - 7.3 kW</b>

**Efficiency**  
94.3%





## MAESTRO 80/3 ECO WAVE

The ultimate 3-sided fire.



Scan this QR code for burning fire.

## MAESTRO 105/3 ECO WAVE

Award-winning gas fire.



Scan this QR code for burning fire.

Because the Dynamic Flame Burner® is incorporated into wood logs that are indistinguishable from the real ones, the flames surround the wood logs just like in a real fire.

### Characteristics:

- 3 high windows
- Optional Clear View glass
- Can be built in without a frame
- Wide output range
- Very high efficiency

### Choose your own size:

(For precise dimensions, see p.90)

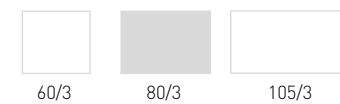

### Maestro 80/3 Eco Wave



Output range	Efficiency
Natural gas G20 <b>1.4 - 9.0 kW</b>	<b>93.0%</b>
Natural gas G25.3 <b>1.3 - 8.6 kW</b>	
Propane G31 <b>1.3 - 7.7 kW</b>	

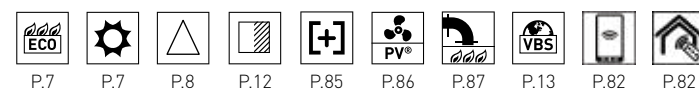

This DRU Eco Wave innovation in the Maestro fires contributes significantly to the "ultimate fire" because the height of the flames can fluctuate from high to low. Natural and lively, just like a real wood fire.

### Characteristics:

- Full flames even at a low setting of the fire
- The unique easy release door system
- Can be built in tightly and without a frame

### Choose your own size:

(For precise dimensions, see p.90)



### Maestro 105/3 Eco Wave



Output range	Efficiency
Natural gas G20 <b>2.2 - 9.3 kW</b>	<b>87.5%</b>
Natural gas G25.3 <b>1.8 - 8.7 kW</b>	
Propane G31 <b>1.5 - 9.6 kW</b>	





## METRO 100XT/3 - 130XT/3 ECO WAVE

Stunning and versatile gas fires.



Metro 100XT/3 Eco Wave

Metro 100XT/3 and 130XT/3 are ideal fires if you want to combine a wide and attractive fire with a view of the fire from several sides.

### Characteristics:

- Wide and deep fire
- Suitable for integrating into a cupboard
- Various interior finishes and fire beds

### Choose your own size:

(For precise dimensions, see p.90)



100XT/3

130XT/3

### Metro 100XT/3 Eco Wave



Output range	Efficiency
Natural gas G20 <b>4.3 - 9.6 kW</b>	<b>83.3%</b>
Natural gas G25.3 <b>3.3 - 9.0 kW</b>	
Propane G31 <b>4.1 - 9.1 kW</b>	

### Metro 130XT/3 Eco Wave



Output range	Efficiency
Natural gas G20 <b>5.1 - 10.8 kW</b>	<b>89.6%</b>
Natural gas G25.3 <b>4.1 - 10.2 kW</b>	
Propane G31 <b>5.6 - 10.6 kW</b>	

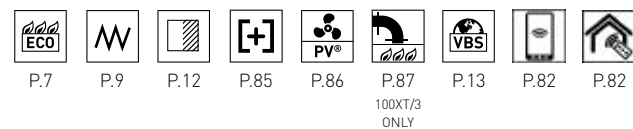

Metro 130XT/3 Eco Wave



Scan this QR code for burning fire.



## LUGO 70/3 - 80/3 ECO WAVE

Beautiful panoramic fires.



Lugo 80/3 Eco Wave

Atmosphere and controllable heat output define the character of these fires with their 3-sided view of the flames. They are suitable for both large and small areas.

### Characteristics

- Bottom frame can be removed for a tighter fit
- Lovely flame pattern with low output
- Complete freedom of installation with PowerVent®

### Choose your own size:

[For precise dimensions, see p.90. 91]

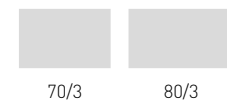

70/3

80/3

### Lugo 70/3 Eco Wave



Output range	Efficiency
Natural gas G20 <b>3.4 - 6.9 kW</b>	<b>91.0%</b>
Natural gas G25.3 <b>2.8 - 6.5 kW</b>	
Propane G31 <b>3.2 - 6.3 kW</b>	

### Lugo 80/3 Eco Wave



Output range	Efficiency
Natural gas G20 <b>3.4 - 6.9 kW</b>	<b>91.0%</b>
Natural gas G25.3 <b>2.8 - 6.5 kW</b>	
Propane G31 <b>3.2 - 6.3 kW</b>	

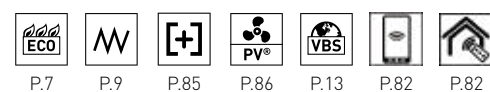



## METRO 100XTL - 130XTL ECO WAVE

Spectacular corner fires.



Metro 130XTL Eco Wave (right)

## MAESTRO 60/2 ECO WAVE

The first fire for all seasons.

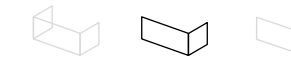

Scan this QR code for burning fire.

Due to their unusual design, the Metro 100XTL - 130XTL are extremely suited for a corner between two areas, such as in a typical L-shaped living space.

### Characteristics:

- Very high efficiency
- Also suited for partially suspended or semi-high built-in
- No visible frames
- Various interior finishes available
- Various fire beds available

### Choose your own size:

(For precise dimensions, see p.91)



100XTL

130XTL

The Maestro 60/2 Eco Wave gas/electric fire features the exclusive Eco Glow mode as an option. LEDs create a comforting glow with minimal heat output and very low energy consumption. Ideal for those evocative summer evenings when the sun has set and you would love to relax next to the fire.

### Characteristics:

- Gas fireplace with a 2-sided view of the fire (left or right version)
- Easy release door system: for easy access to the interior of the fire
- Very high efficiency

### Choose your own size:

(For precise dimensions, see p.91)



60/2

80/2

105/2

### Metro 100XTL Eco Wave



### Metro 130XTL Eco Wave



Output range	Efficiency
Natural gas G20 <b>4.3 - 9.6 kW</b>	<b>83.3%</b>
Natural gas G25.3 <b>3.3 - 9.0 kW</b>	
Propane G31 <b>4.1 - 9.1 kW</b>	

Output range	Efficiency
Natural gas G20 <b>5.1 - 10.8 kW</b>	<b>89.6%</b>
Natural gas G25.3 <b>4.1 - 10.2 kW</b>	
Propane G31 <b>5.6 - 10.6 kW</b>	

Output range	Efficiency
Natural gas G20 <b>5.1 - 10.8 kW</b>	<b>89.6%</b>
Natural gas G25.3 <b>4.1 - 10.2 kW</b>	
Propane G31 <b>5.6 - 10.6 kW</b>	

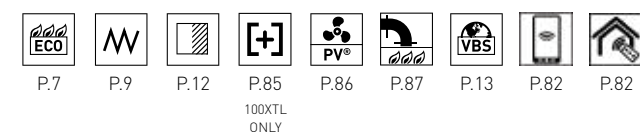

### Maestro 60/2 Eco Wave



Output range	Efficiency
Natural gas G20 <b>1.9 - 7.2 kW</b>	<b>94.3%</b>
Natural gas G25.3 <b>1.6 - 6.8 kW</b>	
Propane G31 <b>1.1 - 7.3 kW</b>	

Output range	Efficiency
Natural gas G20 <b>1.9 - 7.2 kW</b>	<b>94.3%</b>
Natural gas G25.3 <b>1.6 - 6.8 kW</b>	
Propane G31 <b>1.1 - 7.3 kW</b>	





## MAESTRO 80/2 ECO WAVE

The finest 2-sided fire experience.



Scan this QR code for burning fire.

In this corner model of the DRU Maestro Eco Wave series, the flames surround the logs, giving the feeling of a real fire.

### Characteristics:

- Wide output range and complete control with Eco Wave
- Can be built in without a frame
- Left-hand and right-hand versions
- Suspended mounting

### Choose your own size:

(For precise dimensions, see p.91)

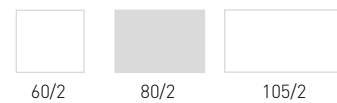

### Maestros 80/2 Eco Wave



Output range	Efficiency
Natural gas G20 <b>1.4 - 9.0 kW</b>	<b>93.0%</b>
Natural gas G25.3 <b>1.3 - 8.6 kW</b>	
Propane G31 <b>1.3 - 7.7 kW</b>	

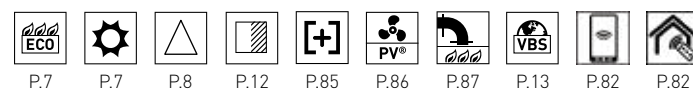

## MAESTRO 105/2 ECO WAVE

The ultimate 2-sided gas fire.

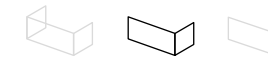

Scan this QR code for burning fire.

This built-in corner fire with a 2-sided view of the flames is deservedly the ultimate fire: available in left-hand or right-hand versions, a second burner that switches on/off, rotating front window, various interior finishes available, optional anti-reflective glass and a sturdy log set.

### Characteristics:

- Can be built in tightly and without a frame
- Custom-made frame available
- The unique Easy release door system
- Various interior finishes
- Can be wall mounted or suspended

### Choose your own size:

(For precise dimensions, see p.91)

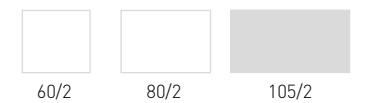

### Maestros 105/2 Eco Wave



Output range	Efficiency
Natural gas G20 <b>2.2 - 9.3 kW</b>	<b>87.5%</b>
Natural gas G25.3 <b>1.8 - 8.7 kW</b>	
Propane G31 <b>1.5 - 9.6 kW</b>	

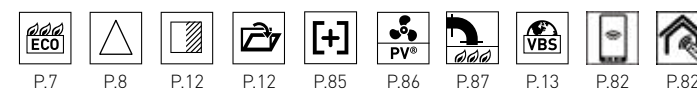





Metro 130XT/2 Eco Wave (left)



Scan this QR code for burning fire.

## METRO 100XT/2 - 130XT/2 ECO WAVE

See both sides of the story.



Metro 100XT/2 Eco Wave (right)

Just like other Metro fires, the Metro 100XT/2 and the Metro 130XT/2 are equipped with the DRU Vario Burner. This burner guarantees high efficiency and a natural flame pattern.

### Characteristics:

- The ambience from a built-in fire with 2-sided view of the flames (left-hand or right-hand version)
- No visible frames
- Various interior finishes available
- Various fire beds available

### Choose your own size:

(For precise dimensions, see p.91)



100XT/2

130XT/2

### Metro 100XT/2 Eco Wave



Output range	Efficiency
Natural gas G20 4.3 - 9.6 kW	83.3%
Natural gas G25.3 3.3 - 9.0 kW	
Propane G31 4.1 - 9.1 kW	

### Metro 130XT/2 Eco Wave



Output range	Efficiency
Natural gas G20 5.1 - 10.8 kW	89.6%
Natural gas G25.3 4.1 - 10.2 kW	
Propane G31 5.6 - 10.6 kW	

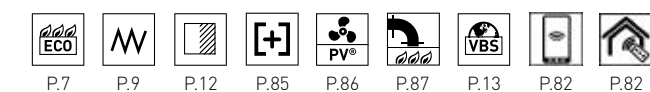



## LUGO 70/2 - 80/2 ECO WAVE

2-Sided fires with lovely flames.



Lugo 70/2 Eco Wave (right)

The Lugo 70/2 - 80/2 are ideal fires for placing in a corner and are available in a left-hand and right-hand versions. There is a fantastic, two-sided view of the fire, many wooden logs and beautiful flames.

### Characteristics:

- Bottom frame can be removed for a tighter fit
- Lovely flame pattern with low output
- Complete freedom of installation with PowerVent®

### Choose your own size:

(For precise dimensions, see p.92)



70/2 80/2

### Lugo 70/2 Eco Wave



### Lugo 80/2 Eco Wave



Output range	Efficiency
Natural gas G20 <b>3.4 - 6.9 kW</b>	<b>91.0%</b>
Natural gas G25.3 <b>2.8 - 6.5 kW</b>	
Propane G31 <b>3.2 - 6.3 kW</b>	

<b>91.0%</b>
--------------

Output range	Efficiency
Natural gas G20 <b>3.4 - 6.9 kW</b>	<b>91.0%</b>
Natural gas G25.3 <b>2.8 - 6.5 kW</b>	
Propane G31 <b>3.2 - 6.3 kW</b>	

<b>91.0%</b>
--------------

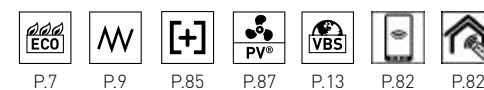

P.7 P.9 P.85 P.87 P.13 P.82 P.82

## PACO ECO WAVE

A versatile fire.



Paco (Inset) Eco Wave

This versatile, multi-functional fire can be placed in a corner or against a flat wall. Moreover, Paco can be entirely built-in or partly built out.

### Characteristics:

- Compact size
- Lovely glow effect
- Low output

### Choose your own size:

(For precise dimensions, see p.92)



Paco

### Paco Eco Wave



Output range	Efficiency
Natural gas G20 <b>2.6 - 5.4 kW</b>	<b>84.8%</b>
Natural gas G25.3 <b>2.1 - 5.0 kW</b>	

<b>84.8%</b>
--------------

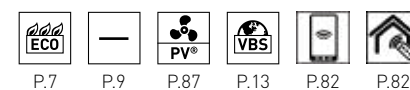

P.7 P.9 P.87 P.13 P.82 P.82



## MAESTRO 75 TALL ECO WAVE

The ultimate fire experience.



New in the Maestro series: a high front fire with a great view of the flames, perfect as the focal point of your room. The Maestro series is known for its lifelike flames and, thanks to Eco Wave, they can be adjusted to your heat requirements all year round.

### Characteristics:

- Optional with Eco Glow glow bed
- Realistic flames
- Frameless installation

### Choose your own size:

[For precise dimensions, see p.92]

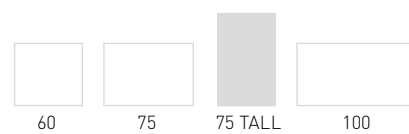

### Maestro 75 Tall Eco Wave



Output range	Efficiency
Natural gas G20 <b>1,7 - 9,2 kW</b>	<b>91,0%</b>
Natural gas G25.3 <b>1,5 - 8,7 kW</b>	
Propane G31 <b>1,5 - 8,2 kW</b>	



Scan this QR code for burning fire.

Maestro 75 Tall Eco Wave



## EXCELLENCE 50XT ECO WAVE

Tall and prominent gas fire.



The DRU Excellence is a gas fire with the atmosphere of a real log fire. The burner is incorporated behind a sturdy log set for a natural and life-like feeling.

### Characteristics:

- A second burner can be switched separately
- Constant full flame pattern
- Remote control with thermostat
- Optional communication module for WiFi control

### Choose your own size:

(For precise dimensions, see p.92)



50XT

### Excellence 50XT Eco Wave

**Output range**  
 Natural gas G20 **2.3 - 7.9 kW**  
 Natural gas G25.3 **1.9 - 7.5 kW**

**Efficiency**  
**87.0%**

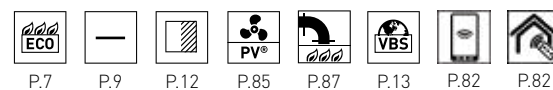

## MAESTRO 60 ECO WAVE

For an all year round fireplace experience.



Scan this QR code for burning fire.

The Maestro 60 Eco Wave front facing gas/electric fire features the exclusive Dynamic Flame Burner®. This unique burner technology, combined with realistic logs and the option of Clear View anti-reflective glass, ensures the ultimate fireplace experience.

### Characteristics:

- Front fire with minimal frames and a wide view of the fire
- Bottom frame removable for a tighter fit
- Optional Eco Glow mode

### Choose your own size:

(For precise dimensions, see p.92)

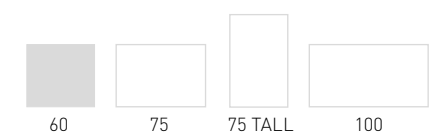

60 75 75 TALL 100

### Maestro 60 Eco Wave

**Output range**  
 Natural gas G20 **1.9 - 7.2 kW**  
 Natural gas G25.3 **1.6 - 6.8 kW**  
 Propane G31 **1.1 - 7.3 kW**

**Efficiency**  
**94.3%**







Scan this QR code for burning fire.

## MAESTRO 75 ECO WAVE

The new generation of gas fires.



The DRU Maestro 75 provides an impressive fire experience due to its realistic logs, dense, high flames and Eco Wave smartphone or tablet controls.

### Characteristics:

- Optional with Clear View (anti-reflective) glass
- Wide output range
- The base can be built in tightly and without a frame

### Choose your own size:

(For precise dimensions, see p.92)

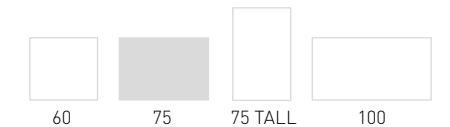

### Maestro 75 Eco Wave

Output range	
Natural gas G20	1.3 - 9.0 kW
Natural gas G25.3	1.2 - 8.6 kW
Propane G31	1.3 - 7.9 kW

Efficiency  
89.0%





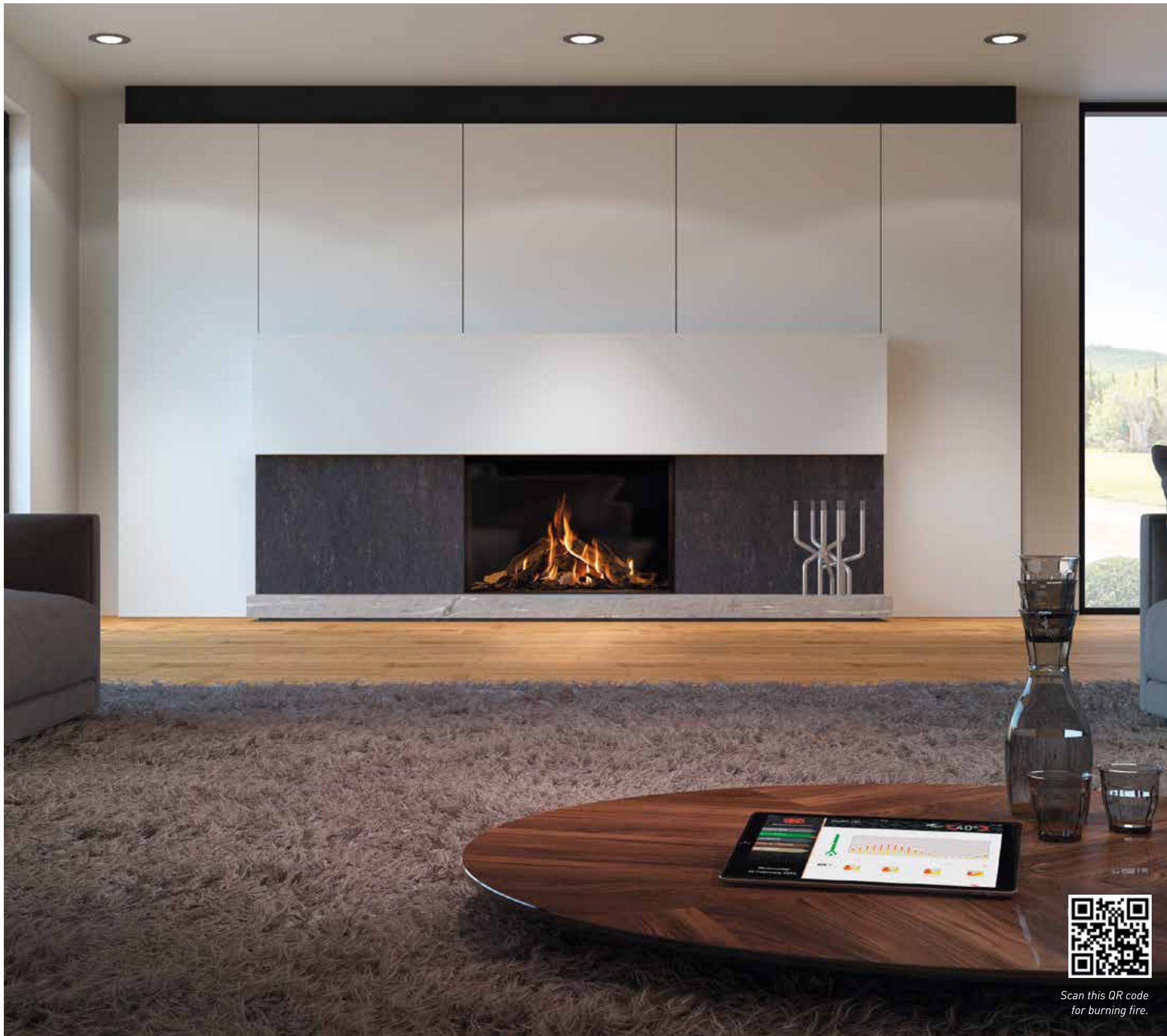

Scan this QR code for burning fire.

## MAESTRO 100 ECO WAVE

Superior gas fire technology.



DRU Maestro is the very latest in contemporary gas fire design. Maestro 100 is the 1 metre wide standard front model with a choice of several interiors and Clear View windows, which replicate the image of an open fire.

### Characteristics:

- Choose from various interior finishes
- Wide output range
- The base can be built in tightly and without a frame

### Choose your own size:

(For precise dimensions, see p.92)

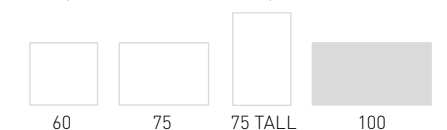

### Maestro 100 Eco Wave



<b>Output range</b>	
Natural gas G20	<b>2.3 - 10.0 kW</b>
Natural gas G25.3	<b>1.9 - 9.3 kW</b>
Propane G31	<b>2.3 - 10.2 kW</b>

**Efficiency**  
92.1%

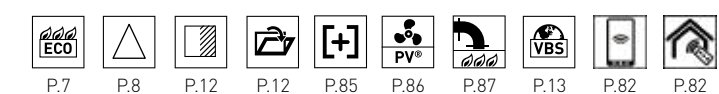





Metro 100XT Eco Wave

## METRO 80XT - 100XT ECO WAVE

Classic hole-in-the-wall fires.



Metro 80XT Eco Wave

The Metro 80XT - 100XT are eminently suitable for contemporary homes where space is limited. The unique burner has flames that zigzag across the entire width and depth of the fireplace.

### Characteristics:

- Log set, white Carrara stones or anthracite glass (Metro 100XT only)
- Optional Ceraglass interior
- Remote control with thermostat
- Optional communication module for WiFi control

### Choose your own size:

(For precise dimensions, see p.92, 93)



### Metro 80XT Eco Wave



Output range	Efficiency
Natural gas G20 <b>3.0 - 5.4 kW</b>	<b>88.9%</b>
Natural gas G25.3 <b>2.3 - 5.1 kW</b>	
Propane G31 <b>2.8 - 5.7 kW</b>	

### Metro 100XT Eco Wave



Output range	Efficiency
Natural gas G20 <b>4.3 - 9.6 kW</b>	<b>83.3%</b>
Natural gas G25.3 <b>3.3 - 9.0 kW</b>	
Propane G31 <b>4.1 - 9.1 kW</b>	

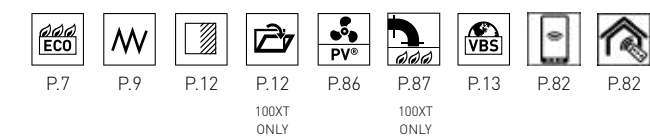





Metro 130XT Eco Wave

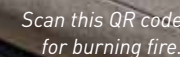

Scan this QR code for burning fire.

## METRO 130XT - 150XT ECO WAVE

An expansive choice.



Metro 150XT Eco Wave

Special features of these extra-wide fires are the realistic log sets and the unique burners, with flames that zigzag across the entire width and depth of the fires.

### Characteristics:

- Unique flame pattern
- Available with various interior finishes
- Choose from the various fire beds

### Choose your own size:

(For precise dimensions, see p.93)



### Metro 130XT Eco Wave



Output range	Efficiency
Natural gas G20 <b>5.1 - 10.8 kW</b>	<b>89.6%</b>
Natural gas G25.3 <b>4.1 - 10.2 kW</b>	
Propane G31 <b>5.6 - 10.6 kW</b>	

### Metro 150XT Eco Wave



Output range	Efficiency
Natural gas G20 <b>5.9 - 10.8 kW</b>	<b>87.9%</b>
Natural gas G25.3 <b>4.9 - 10.3 kW</b>	
Propane G31 <b>5.3 - 11.1 kW</b>	





## METRO 200XT ECO WAVE

Wide, wider, widest.



The lavish Metro 200XT fire not only creates atmosphere, but also provides considerable warmth in large living spaces. A special feature of this 200 cm wide fire is its realistic log set, which is nearly indistinguishable from real logs.

### Characteristics:

- Unique zigzag burner for a wide and deep fire
- Realistic log set
- Flames over the entire width of the fire
- Total control with Eco Wave

### Choose your own size:

(For precise dimensions, see p.93)

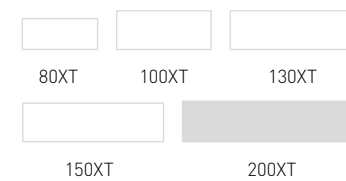

### Metro 200XT Eco Wave



#### Output range

Natural gas G20 **8.9 - 16.7 kW**  
Natural gas G25.3 **7.2 - 15.8 kW**

#### Efficiency

**90.3%**

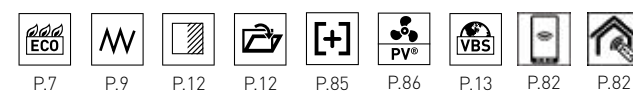

## COSMO ECO WAVE

Impressive in size and output.

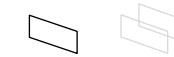

With its output and its impressive size of 180 cm width and 80 cm height, the Cosmo provides the ultimate ambience for large living areas.

### Characteristics:

- Optional addition is the lovely Murano chimney (stainless steel casing and limestone hearth)
- Easy to clean glass due to the Easy release door system
- Wide output range and complete control with Eco Wave

### Choose your own size:

(For precise dimensions, see p.93)



### Cosmo Eco Wave



#### Output range

Natural gas G20 **6.0 - 16.3 kW**  
Natural gas G25.3 **4.9 - 15.7 kW**

#### Efficiency

**89.3%**





## MAESTRO 75 TALL TUNNEL ECO WAVE

The ultimate room divider.



Great 2-sided fire view with the new Maestro Tall tunnel fire. The high window and realistic flames provide an optimal fire experience from two rooms. A true statement-maker in your home, and it meets today's stringent energy requirements.

### Characteristics:

- High efficiency, so economical
- Optional with Eco Glow bed
- Tight and frameless to build in

### Choose your own size:

[For precise dimensions, see p.92]

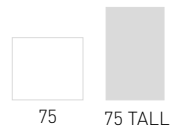

### Maestro 75 Tall Tunnel Eco Wave



Output range	Efficiency
Natural gas G20 <b>2,0 - 10,2 kW</b>	<b>92,0%</b>
Natural gas G25.3 <b>1,7 - 9,5 kW</b>	
Propane G31 <b>2,0 - 10,0 kW</b>	



Scan this QR code for burning fire.

Maestro 75 Tall Tunnel Eco Wave



## MAESTRO 75 TUNNEL ECO WAVE

The ultimate room divider.



The Maestro 75 Tunnel is a spectacular room divider for a dining room and living room, kitchen or even a conservatory. This fire has black side walls and a Dynamic Flame Burner®. This unique burner is built into ceramic wood logs, causing the flames to lap around them.

### Characteristics:

- Suitable for installation between two rooms
- Ideal as a room divider
- Very high 93% efficiency
- With Easy release door system, drop down door for easy cleaning and maintenance of your fire

### Choose your own size:

[For precise dimensions, see p.92]

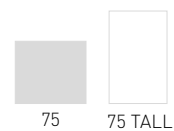

### Maestro 75 Tunnel Eco Wave



#### Output range

Natural gas G20 **1,7 - 9,1 kW**  
 Natural gas G25.3 **1,5 - 8,5 kW**  
 Propane G31 **1,9 - 9,5 kW**

#### Efficiency

**93,0%**

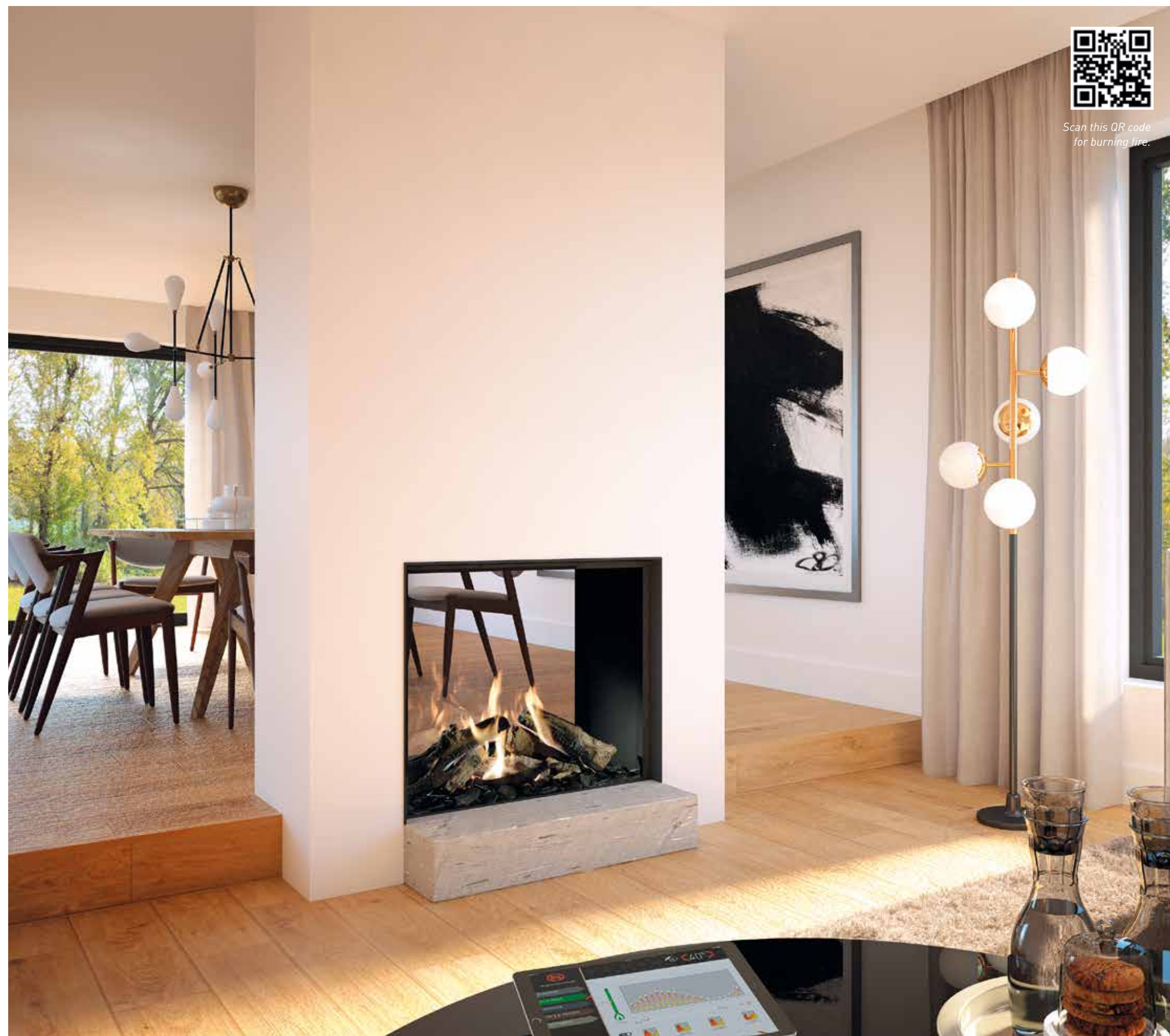
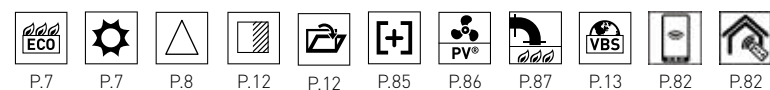

Scan this QR code for burning fire.



## METRO 80XT - 100XT TUNNEL ECO WAVE

Two sides of the same fire.



Metro 80XT Tunnel Eco Wave

Metro 80XT Tunnel and 100XT Tunnel enable you to enjoy the fire from two sides, making it ideal as a room divider.

### Characteristics:

- Realistic log set or white Carrara stones
- Fire over the entire width
- If combined with PowerVent®, it can be installed anywhere in the home

Choose your own size: [For precise dimensions, see p.92, 93]



### Metro 80XT Tunnel Eco Wave



Output range	Efficiency
Natural gas G20 <b>3.0 - 5.4 kW</b>	<b>88.9%</b>
Natural gas G25.3 <b>2.3 - 5.1 kW</b>	
Propane G31 <b>2.8 - 5.7 kW</b>	

Efficiency

### Metro 100XT Tunnel Eco Wave



Output range	Efficiency
Natural gas G20 <b>4.3 - 9.6 kW</b>	<b>83.3%</b>
Natural gas G25.3 <b>3.3 - 9.0 kW</b>	
Propane G31 <b>4.1 - 9.1 kW</b>	

Efficiency

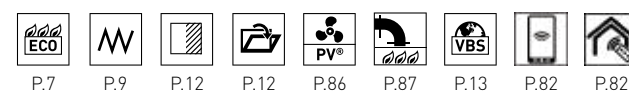

P.7 P.9 P.12 P.12 P.86 P.87 P.13 P.82 P.82

100XT  
TUNNEL  
ONLY



Metro 100XT Tunnel Eco Wave



## METRO 130XT TUNNEL ECO WAVE

Dancing flames from both sides.



Scan this QR code for burning fire.

Metro 130XT tunnel fire has the a unique zigzag burner that virtually fills the entire width and depth of the fire with flames.

### Characteristics:

- Ideal as a room divider
- Natural log set or stones
- Also available in LPG
- Very high 89,6% efficiency
- If combined with PowerVent®, it can be placed anywhere in the house

### Choose your own size:

(For precise dimensions, see p.93)

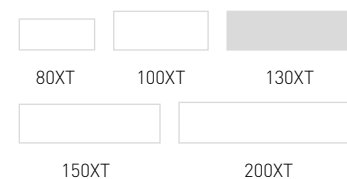

### Metro 130XT Tunnel Eco Wave

Output range	Efficiency
Natural gas G20 <b>5.1 - 10.8 kW</b>	<b>89.6%</b>
Natural gas G25.3 <b>4.1 - 10.2 kW</b>	
Propane G31 <b>5.6 - 10.6 kW</b>	

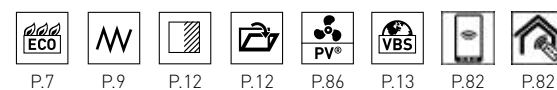

## METRO 150XT - 200XT TUNNEL ECO WAVE

Wide and impressive tunnel fires.



Metro 150XT Tunnel Eco Wave

This lavish 150 cm/200 cm tunnel fire not only creates a great atmosphere, but also provides considerable warmth in large areas. These impressive fires have large, realistic logs, which closely replicate the look of a real fire.

### Characteristics:

- Metro 150XT Tunnel is available with authentic brown or white birch log sets
- The large glass window is easy to clean.
- Fire over the entire width
- Remote control with thermostat

### Choose your own size:

(For precise dimensions, see p.93)

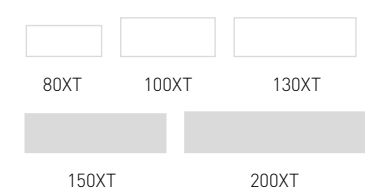

### Metro 150XT Tunnel Eco Wave

Output range	Efficiency
Natural gas G20 <b>5.9 - 10.8 kW</b>	<b>87.9%</b>
Natural gas G25.3 <b>4.9 - 10.3 kW</b>	
Propane G31 <b>5.3 - 11.1 kW</b>	

### Metro 200XT Tunnel Eco Wave

Output range	Efficiency
Natural gas G20 <b>8.9 - 16.7 kW</b>	<b>90.3%</b>
Natural gas G25.3 <b>7.2 - 15.8 kW</b>	

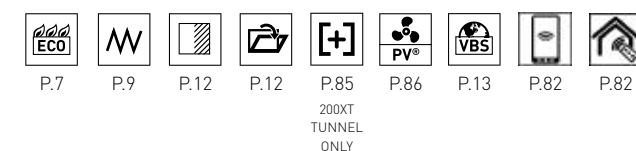



## COSMO TUNNEL ECO WAVE

An impressive flame picture from both sides.



Cosmo Tunnel is designed for dividing walls or room features. Built-in tightly or combined with an impressive chimney, Cosmo Tunnel is a guaranteed eye catcher.

### Characteristics:

- Suitable as a room divider
- Optional Murano chimney (stainless steel casing and limestone hearth)
- Easy release door system on both sides
- Wide output range and complete control with Eco Wave
- The base can be built in without a frame

### Choose your own size:

[For precise dimensions, see p.93]

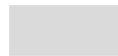

Cosmo

Cosmo Tunnel Eco Wave



### Output range

Natural gas G20 **6.0 - 16.3 kW**

Natural gas G25.3 **4.9 - 15.7 kW**

### Efficiency

**89.3%**





## CIRCO

Beautiful cylindrical stove.



Circo is a freestanding gas stove that makes an elegant focal point anywhere in the home. The curved window offers a view from several corners of the room.

### Characteristics:

- Programmable timer that can set the temperature to a comfortable level or a rest level
- Remote control with thermostat

### Choose your own size:

(For precise dimensions, see p.93)



Circo

Circo

A

### Output range

Natural gas G20 **2.9 - 7.0 kW**  
 Natural gas G25.3 **2.7 - 6.0 kW**  
 Propane G31 **2.8 - 6.2 kW**

### Efficiency

**92.5%**



P.9 P.13 P.82

## POLO

Stylish and functional gas stove.



Due to its limited output of around 4 kW, this beautiful three-sided free-standing gas stove is very suitable for well insulated and small rooms such as kitchens, conservatories or living rooms.

### Characteristics:

- Moderate heat output
- Various interior finishes available
- Programmable timer that can set the temperature to a comfortable level or a rest level

### Choose your own size:

(For precise dimensions, see p.93)



Polo

Polo

A

### Output range

Natural gas G20 **1.6 - 4.1 kW**  
 Natural gas G25.3 **1.5 - 3.8 kW**  
 Propane G31 **1.6 - 3.8 kW**

### Efficiency

**92.6%**



P.9 P.13 P.82



## TRIO

Elegant and powerful.



Trio is a freestanding stove with a slender form and an imposing look. It makes a beautiful centrepiece in a large or small living room.

### Characteristics:

- A fire with a 3D-effect, visible from several locations in the room
- High display of flames with a glowing effect
- Remote control with thermostat

### Choose your own size:

(For precise dimensions, see p.93)



Trio

Trio

B

**Output range**  
 Natural gas G20 **2.0 - 4.5 kW**  
 Natural gas G25.3 **1.8 - 4.2 kW**  
 Propane G31 **1.5 - 4.0 kW**

**Efficiency**  
**85.4%**



P.9 P.13 P.82

## DIABLO NEXT

Fits everywhere.



Due to its limited output of around 4 kW, this beautiful three-sided suspended gas fire is very suitable for all types of room.

### Characteristics:

- Wall mounted, takes no floor space
- Available in black or aluminium-metallic finish
- Optional ornamental cover available for concealing the flue pipe
- Remote control with thermostat

### Choose your own size:

(For precise dimensions, see p.93)



Diablo

Diablo Next

A

**Output range**  
 Natural gas G20 **1.6 - 4.1 kW**  
 Natural gas G25.3 **1.5 - 3.8 kW**  
 Propane G31 **1.6 - 3.8 kW**

**Efficiency**  
**92.6%**



P.9 P.13 P.82



## PASSO ECO WAVE

180 degrees view of the fire.



This cool free-standing gas fire catches the eye thanks to its large round glass window. The flame patterns can be regulated by means of the integrated Eco Wave technology. The glowing effect at the bottom of the gas fire and high-stacked logs create a beautiful fire. The gas fire can be operated with a remote control or through your smartphone or tablet.

### Characteristics:

- Revolving door for easy cleaning
- Available in 6 colours
- Beautiful high flame display and low gas use

### Choose your own size:

[For precise dimensions, see p.94]



Passo



Nero

Titan

Pearl

White

Light grey

Turquoise

Passo Eco Wave



### Output range

Natural gas G20 **1,2 - 6,4 kW**

Natural gas G25.3 **0,9 - 6,1 kW**

### Efficiency

**93,0%**



Scan this QR code for burning fire.



## LUGO 70/3 MODULE ECO WAVE

Easy to install with choice of colours.

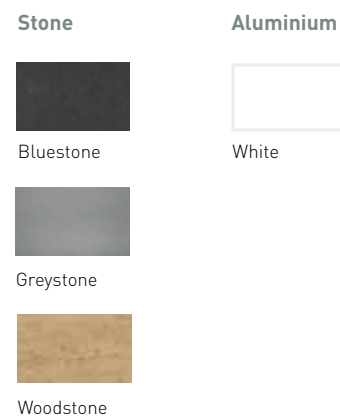

Lugo 70/3 Module is a three-sided fire equipped with the Eco Wave burner technology that allows you to set 15 different flame pattern levels .

### Characteristics:

- Very realistic log set
- Always a full flame pattern
- Remote control with thermostat
- Optional communication module for WiFi control

### Aluminium finish:

- Beautiful luxurious look
- Extremely suitable for modern interiors

### Choose your own size:

(For precise dimensions, see p.94)

Lugo 70/3 Module

### Stone finish

- Resistant to extremely high temperatures
- Scratch-resistant
- Easy to clean
- 100% natural and recyclable



### Lugo 70/3 Module Eco Wave

Output range	
Natural gas G20	3.4 - 6.9 kW
Natural gas G25.3	2.8 - 6.5 kW
Propane G31	3.2 - 6.3 kW

Efficiency  
91.0%



## MAESTRO 60/3 MODULE ECO WAVE

Gas fire with the appearance of a wood stove.



Modern luxury freestanding gas fire. The 3-sided fire is available with white or grey paneling. The Maestro 60/3 Module has the looks of a freestanding wood fire but offers all the benefits of gas.

### Characteristics:

- Lifelike and full 3-sided flame pattern
- Optional with Eco Glow bed
- Easy to clean thanks to the Easy release door system

### Aluminium finish:

- White or grey

### Choose your own size:

(For precise dimensions, see P. 94)

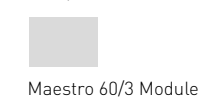

### Maestro 60/3 module Eco Wave

Output range	
Natural gas G20	1.9 - 7.2 kW
Natural gas G25.3	1.6 - 6.8 kW
Propane G31	1.1 - 7.3 kW

Efficiency  
94,3 %







Global  
BY DRU

...TO MAKE *you* FEEL AT HOME

## GLOBAL BY DRU PRODUCT RANGE

*Global by DRU gas fires are perfectly well balanced between desirability and affordability. With so many options, there is always a fire that fits with your interior design.*

Due to their **shallow depth**, the compact Global gas fires are suitable for nearly every room, regardless of whether you live in a mid-terrace house or an apartment. **Installing is simple, prices are attractive, the quality is excellent** and the many options allow you to personalise your fire. That makes Global gas fires suitable for virtually everyone.

In the Global gas fire collection, you can select front fires with one side in glass and 2-sided and 3-sided fires for a view of the flames from various angles.

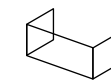

3-Sided fires  
[P. 71]

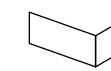

2-Sided fires  
[P. 74]



Front fires  
[P. 68, 76]

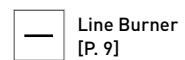

Line Burner  
[P. 9]

The Line Burner provides a lovely tight flame pattern over the width of the fire.



Clear View glass  
[P. 12]

No bothersome reflections; always a clear view of the fire.



Safety Control System  
(Dutch: VBS) [P. 13]

These fires are completely suitable for various types of gasses and fully prepared for the future.



CF Open combustion

- Oxygen comes from the living area
- Flue gas exhaust via a single pipe
- Possible with an existing chimney
- Usually inexpensive and easy to implement



Domotica Home Automation [P. 82]

Possibility to connect to home automation systems for smart control in the home.



Truflame Burner®  
[P. 8]

Double log burner for a wide/deep fire and a very high flame picture.



Direct flue  
[P. 87]

Directly on the fire via a 90° pipe bend to the outside.



BF Closed combustion

- Oxygen comes from outside the building
- Extraction of flue gases via wall or roof
- Inlet and outlet via double-walled pipe
- Preferred option for well-insulated or mechanically-ventilated properties



## GLOBAL 55 CF

Compact and convenient gas fires.



The Global 55 CF is a gas fire with a minimal build in depth. Therefore the fire takes up little space and, partly on account of its relatively low output, is superb for smaller living spaces.

### Characteristics:

- Compatible with existing chimneys
- Remote control with a thermostat and clock
- Shallow build in depth

### Choose your own size:

(For precise dimensions, see p.94)



### Global 55 CF



#### Output range

Natural gas G20 **1,9 - 3,9 kW**  
 Natural gas G25.3 **1,5 - 3,7 kW**  
 Propane G31 **1,9 - 4,0 kW**

#### Efficiency

**77,7%**



## GLOBAL 55XT CF

Compact and convenient gas fires.



The Global 55XT CF is equipped with the unique Truflame Burner®. This is enclosed in wood-effect ceramic logs. This causes the flames to lap around them, creating a realistic flame pattern. Thanks to its dimensions, the fire can be installed in an existing chimney.

### Characteristics:

- Compatible with existing chimneys
- With unique Truflame Burner®, realistic fire view with generous glowing embers
- Extensive choice of interior finishes
- Optional Clear View (anti-reflective) glass
- Slimline build in depth

### Choose your own size:

(For precise dimensions, see p.94)



### Global 55XT CF



#### Output range

Natural gas G20 **2,8 - 3,7 kW**  
 Natural gas G25.3 **2,6 - 3,5 kW**

#### Efficiency

**74,3%**

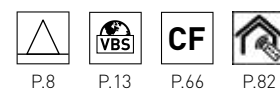



## GLOBAL 70XT CF

Transform your old fireplace.



The Global 70XT CF is an excellent addition to the attractively priced Global by DRU product range. It can be built into an existing chimney, with no visible openings.

### Characteristics:

- Extra depth by means of a flat rear wall
- Stone interior finish for a classic look
- Various interior finishes
- Remote control with a thermostat and clock

### Choose your own size:

(For precise dimensions, see p.94)



### Global 70XT CF



Output range	Efficiency
Natural gas G20 <b>3.1 - 4.5 kW</b>	<b>77.1%</b>
Natural gas G25.3 <b>2.7 - 4.4 kW</b>	
Propane G31 <b>4.0 - 4.6 kW</b>	



## GLOBAL 60 TRIPLE BF

3-Sided view of the fire.



With this stylish 3-sided fire you have a great view of the fire from every corner of your room.

### Characteristics:

- Choose from two types of interior finishes
- Countless options for building in
- Very shallow built-in depth
- Remote control with a thermostat and clock

### Choose your own size:

(For precise dimensions, see p.94)



### Global 60 Triple BF



Output range	Efficiency
Natural gas G20 <b>2.3 - 6.0 kW</b>	<b>91.5%</b>
Natural gas G25.3 <b>2.1 - 5.4 kW</b>	
Propane G31 <b>3.0 - 6.2 kW</b>	





## GLOBAL 100 TRIPLE BF - 120 TRIPLE BF

All round style and comfort.



Global 100 Triple BF

The compact design of the Global 100 and 120 Triple BF is characterised by its minimal frames and a wide panoramic fire display.

### Characteristics:

- Limited built-in depth of 38 cm
- Fits into any type of interior
- High efficiency of 94.0%
- Remote control with a thermostat and clock

### Choose your own size:

(For precise dimensions, see p.94)



60 Triple BF    100 Triple BF    120 Triple BF

### Global 100 Triple BF



Output range	Efficiency
Natural gas G20 <b>2.8 - 7.5 kW</b>	<b>94.0%</b>
Natural gas G25.3 <b>2.6 - 7.1 kW</b>	
Propane G31 <b>3.5 - 7.0 kW</b>	

### Global 120 Triple BF



Output range	Efficiency
Natural gas G20 <b>2.8 - 7.5 kW</b>	<b>94.0%</b>
Natural gas G25.3 <b>2.6 - 7.1 kW</b>	
Propane G31 <b>3.5 - 7.0 kW</b>	



Scan this QR code for burning fire.



Global 100 Triple BF



## GLOBAL 60 CORNER BF

Beautiful 2-Sided gas fire.

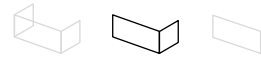

Global 60 Corner BF is very suitable for positioning in a corner, providing you with a view of the fire from two sides.

### Characteristics:

- Very shallow built-in depth
- Available with two interiors: smooth black or Ceraglass
- Remote control with a thermostat and clock

### Choose your own size:

(For precise dimensions, see p.95)



60 Corner BF 100 Corner BF 120 Corner BF

### Global 60 Corner BF



Output range	
Natural gas G20	<b>2.3 - 6.0 kW</b>
Natural gas G25.3	<b>2.1 - 5.4 kW</b>
Propane G31	<b>3.0 - 6.2 kW</b>

Efficiency
<b>91.5%</b>

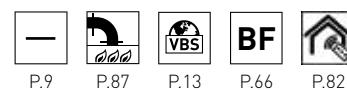

P.9 P.87 P.13 P.66 P.82

## GLOBAL 100 CORNER BF - 120 CORNER BF

A 2-Sided fireplace experience.

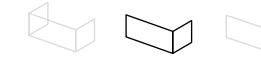

Global 120 Corner BF (left)



Scan this QR code for burning fire.

Global 100 and 120 Corner BF is characterised by a wide panoramic front view of the fire. The open view on the left and right side allows you to enjoy the fire on two sides.

### Characteristics:

- Shallow built-in depth of 38 cm
- Minimalist frames
- High efficiency
- Remote control with a thermostat and clock

### Choose your own size:

(For precise dimensions, see p.95)



60 Corner BF 100 Corner BF 120 Corner BF

### Global 100 Corner BF



Output range	
Natural gas G20	<b>2.8 - 7.5 kW</b>
Natural gas G25.3	<b>2.6 - 7.1 kW</b>
Propane G31	<b>3.5 - 7.0 kW</b>

Efficiency
<b>94.0%</b>



P.9 P.87 P.13 P.66 P.82

### Global 120 Corner BF



Output range	
Natural gas G20	<b>2.8 - 7.5 kW</b>
Natural gas G25.3	<b>2.6 - 7.1 kW</b>
Propane G31	<b>3.5 - 7.0 kW</b>

Efficiency
<b>94.0%</b>



## GLOBAL 55XT CAVITY BF

*The perfect solution. No Chimney - No space lost - Perfect flames.*



### The perfect fireplace solution for homes with no chimney

The new DRU Global 55XT Cavity BF wall fire is the perfect solution for homes without a traditional chimney or where a false chimneybreast is not an option. With its slim depth and perfect log flame effect, created by the unique Truflame Burner®, this stunning fire can easily be installed into your home's cavity wall without losing valuable floor space. With its rear-vented balanced flue, the Global 55XT Cavity BF wall gas fire is the perfect solution for any home.

#### Characteristics:

- Suitable for installation in a cavity
- Depth only 255 mm
- Eccentric concentric flue (Ø 150/100 mm) on left side
- Snorkel flue and convection box included
- With unique Truflame Burner®, burner is built into ceramic wood logs, causing the flames to lap around them

#### Choose your own size:

(For precise dimensions, see p.95)



55XT  
CAVITY  
BF



Truflame Burner®

Global 55XT Cavity BF



#### Output range

Natural gas G20 **1.8 - 3.2 kW**

#### Efficiency

**77.4%**



P.8



P.12



P.13



P.66



P.82

UK ONLY

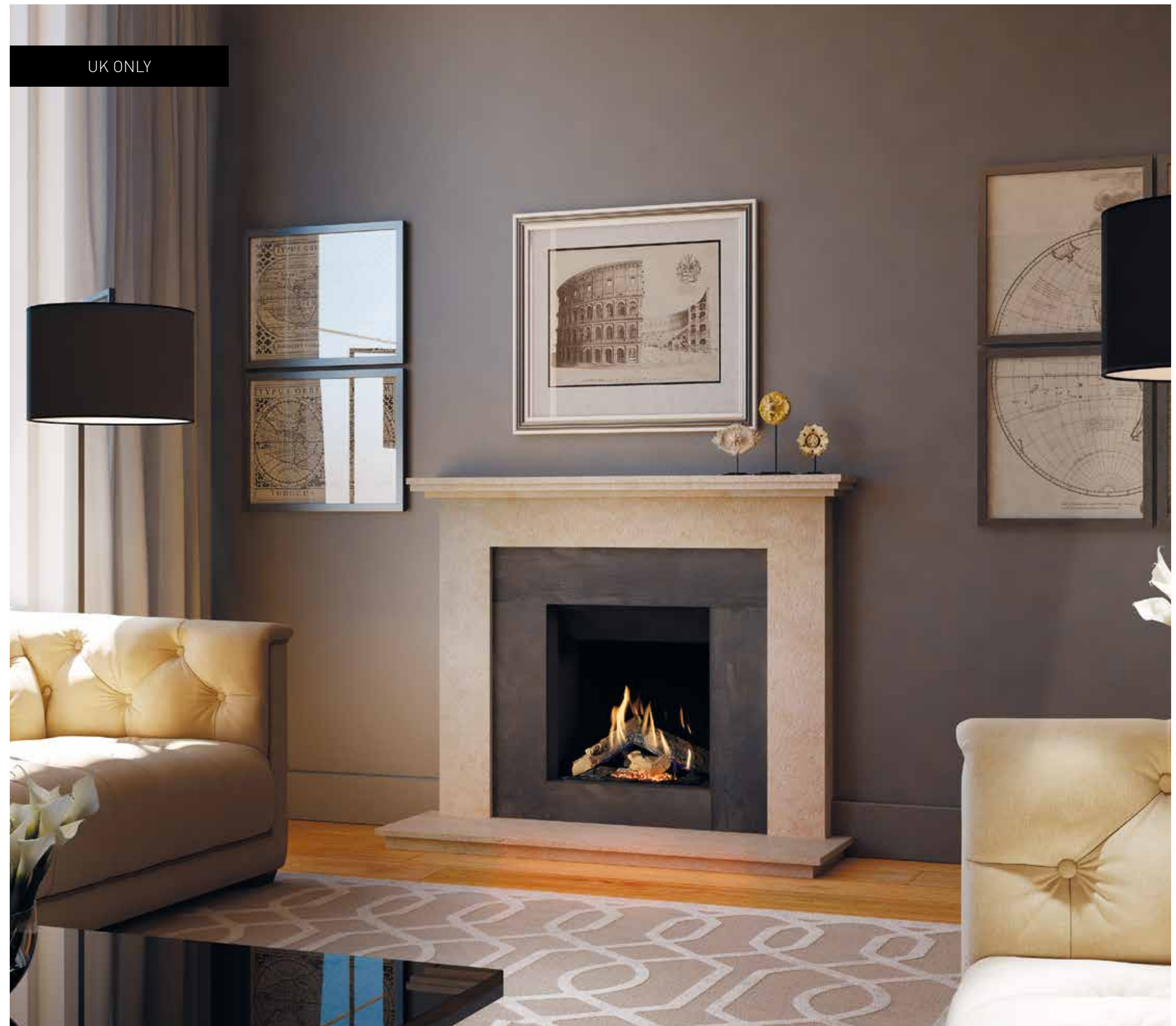



## GLOBAL 55XT BF – 70XT BF

Gas fires with very realistic high and dense flames.



Global 55XT BF

These built-in front fires are provided with a unique Truflame Burner®. This burner is built into ceramic wood logs, causing the flames to lap around them and looks like a real wood fire. Both fires have a choice of different types of interior finish.

### Characteristics:

- With unique Truflame Burner®
- Realistic fire view with a wide glow effect
- Shallow build in depth
- Optional Clear View (anti-reflective) glass

### Choose your own size:

(For precise dimensions, see p.95)

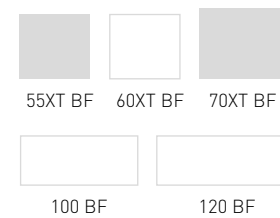

### Global 55XT BF



Output range	Efficiency
Natural gas G20 <b>2.6 - 4.6 kW</b>	<b>92.6%</b>
Natural gas G25.3 <b>2.4 - 4.3 kW</b>	
Propane G31 <b>3.1 - 4.4 kW</b>	

### Global 70XT BF



Output range	Efficiency
Natural gas G20 <b>3.4 - 5.7 kW</b>	<b>92.7%</b>
Natural gas G25.3 <b>3.1 - 5.3 kW</b>	
Propane G31 <b>3.2 - 5.5 kW</b>	



Global 70XT BF



## GLOBAL 60XT BF

Compact and captivating.



Global 60XT BF is a compact and impressive built-in fire. The narrow frame and the shallow build in depth makes it very suitable for rooms where space is limited.

### Characteristics:

- Front fire view
- Narrow frames
- Very shallow build in depth
- Various interior finishes available
- Remote control with a thermostat and clock

### Choose your own size:

(For precise dimensions, see p.95)

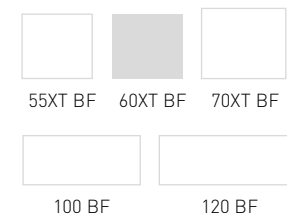

### Global 60XT BF

Output range	
Natural gas G20	<b>2.5 - 6.5 kW</b>
Natural gas G25.3	<b>2.3 - 6.0 kW</b>
Propane G31	<b>3.3 - 6.8 kW</b>

Efficiency  
**91.9%**

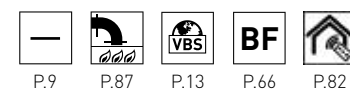

P.9 P.87 P.13 P.66 P.82

## GLOBAL 100 BF - 120 BF

Beautiful landscape gas fires.



Global 120 BF

Global 100 BF and 120 BF are built in fires with high efficiency and a wide panoramic view of the fire flames.

### Characteristics:

- Shallow build in depth
- Very high efficiency
- Attractive price
- Remote control with a thermostat and clock

### Choose your own size:

(For precise dimensions, see p.95)

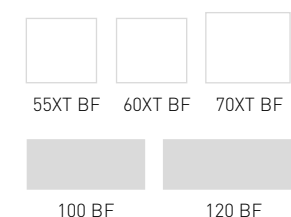

### Global 100 BF

Output range	Efficiency
Natural gas G20	<b>2.8 - 7.5 kW</b> <b>94.0%</b>
Natural gas G25.3	<b>2.6 - 7.1 kW</b>
Propane G31	<b>3.5 - 7.0 kW</b>

### Global 120 BF

Output range	Efficiency
Natural gas G20	<b>2.8 - 7.5 kW</b> <b>94.0%</b>
Natural gas G25.3	<b>2.6 - 7.1 kW</b>
Propane G31	<b>3.5 - 7.0 kW</b>

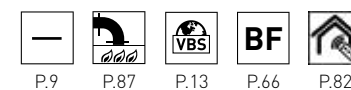

P.9 P.87 P.13 P.66 P.82



## REMOTE CONTROL, APP, CONTROL HATCH

Useful accessories that make your life easier.

# ADDED CONVENIENCE

To make it easier to use your fire, there are various accessories available (depending on the type of fire).



### RCH remote control (DRU)

- robust look
- extensive control functions
- Honeywell control



### RCE remote control (DRU and Global by DRU)

- modern design
- easy to use
- Mertik control

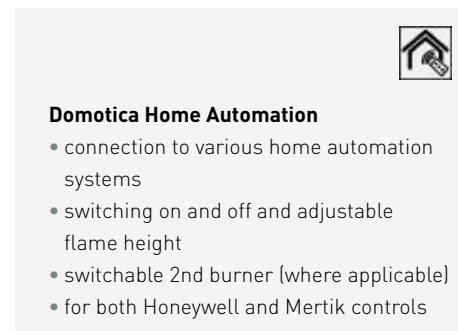

### Domotica Home Automation

- connection to various home automation systems
- switching on and off and adjustable flame height
- switchable 2nd burner (where applicable)
- for both Honeywell and Mertik controls

All remote controls have electronic ignition, thermostat and clock.



### App + communication module

Do you want to have full control of the flame pattern? Choose the Eco Wave communication module. With a DRU Control App that you can download for free to your smartphone and tablet (IOS/Android), you not only control the fire, but you also set the flame pattern. This is suitable only for fires with the Eco Wave system.



### Management module

DRU and ICY developed a module specifically for the recreation sector (holiday parks, hotels, etc.) to operate gas fires on site as well as from a reception system.

- Includes movement and light sensors for conscious use of energy
- Innovative and easy to use
- Separate remote control and batteries are no longer necessary



### Control hatch

For maintenance and in case of faults, DRU has developed a special control hatch that integrates nicely into the set-up of the fire and allows easy access to the gas regulating block.

## LUXURY ELEMENTS

Cove ventilation for the protection of your chimney breast.

# STYLISH VENTILATION

When using your fire, heat builds up in the chimney breast. It is therefore necessary to ventilate in order not to cause cracks. For this purpose, DRU has developed various LUX elements in ivory-white, alu-metallic and anthracite. These are integrated into the casing and can also have the option of providing supplementary light.

- 1 Ivory-white
- 2 Alu-metallic
- 3 Anthracite



Lux Fino 1 3



Lux Sleeve 1 2



Lux Lignum 1 2



Lux Omni 1 2



Lux 1 2





FRAMELESS AND  
TIGHT FINISH

## STANDARD, FRAMELESS OR CUSTOMISED

Choose from a range of frames for your new fire.

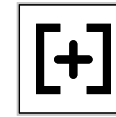

## FRAMES

### Standard frames or frameless

All DRU fires are fitted with a frame as standard. Would you rather seamlessly integrate the fire into the rest of your room? With some fires it is possible to remove the lower part of the frame. This way the fire can be tightly built into a natural stone plateau or recessed into the floor, directly against the glass pane.

### Customisation possible

To further personalise your fire, DRU offers you the option of frames in different widths with the below built-in fires. The frames are available in a width of 100 mm (except Maestro 60: 110 or 140 mm, Maestro 75 Tall-Tall Tunnel: 100 or 130 mm), but can also be made to measure. In the overview below you can immediately see for which fires this is possible.



Frameless, bottom frame removed



Standard frame



Optional frame (customisation possible)

Fires that can be built in without a frame			
3-Sided fires	2-Sided fires	Front fires	Tunnel fires
Maestro 75XTU	Maestro 60/2	Maestro 60	Maestro 75 Tunnel
Maestro 60/3	Maestro 80/2	Maestro 75	Metro 200XT Tunnel
Maestro 80/3	Maestro 105/2	Maestro 100	Cosmo Tunnel
Maestro 105/3	Metro 100XT/2	Metro 200XT	
Metro 100XT/3	Metro 130XT/2	Cosmo	
Metro 100XTL	Lugo 70/2		
Metro 100XTU	Lugo 80/2		
Metro 130XT/3			
Lugo 70/3			
Lugo 80/3			

Optional frames			
3-Sided fires	2-Sided fires	Front fires	Tunnel fires
Maestro 75XTU	Maestro 60/2	Maestro 60	Maestro 75 Tall Tunnel
Maestro 60/3	Maestro 80/2	Maestro 75 Tall	
Maestro 80/3	Maestro 105/2		
Maestro 105/3	Metro 100XT/2		
Metro 100XT/3	Metro 130XT/2		
Metro 100XTL	Lugo 70/2		
Metro 100XTU	Lugo 80/2		
Metro 130XT/3			
Lugo 70/3			
Lugo 80/3			

Customisation possible 90 mm - 200 mm

(Maestro 60: 70 mm - 200 mm, Maestro 60/2-60/3-75XTU: 100 mm - 200 mm, Maestro 75 Tall-Tall Tunnel: op demand)



## POSITIONING POSSIBILITIES

Freedom to place your fire where you want it.

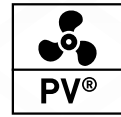

# NO CHIMNEY AT YET A PERFECT PLACE FOR A GAS FIRE?

Install a gas fire, right in the place where you want it. Installation in an existing chimney situation or without chimney directly against an exterior wall is usually quite simple. However, DRU also offers you a solution in other, more complex situations. With the PowerVent® technology from DRU the possibilities are virtually unlimited; think of placement, for example in the middle of your room, in your apartment, restaurant, hotel or in a showroom. The patented innovation PowerVent® allows the flue to run through the crawl space, lengths up to 100 meters

to be bridged, or routes with several turns. PowerVent® from DRU gives you the freedom to think up solutions.

### Benefits DRU PowerVent®

- Complete freedom of placement
- Ideal for terraced houses, apartments, restaurants, hotels, shops and farms
- Flue lengths up to 100 meters
- Flue route possible through the crawl space
- Flue runs with numerous bends

### Existing chimneys



Via the roof  
• flexible pipe in the chimney

### PowerVent® solutions

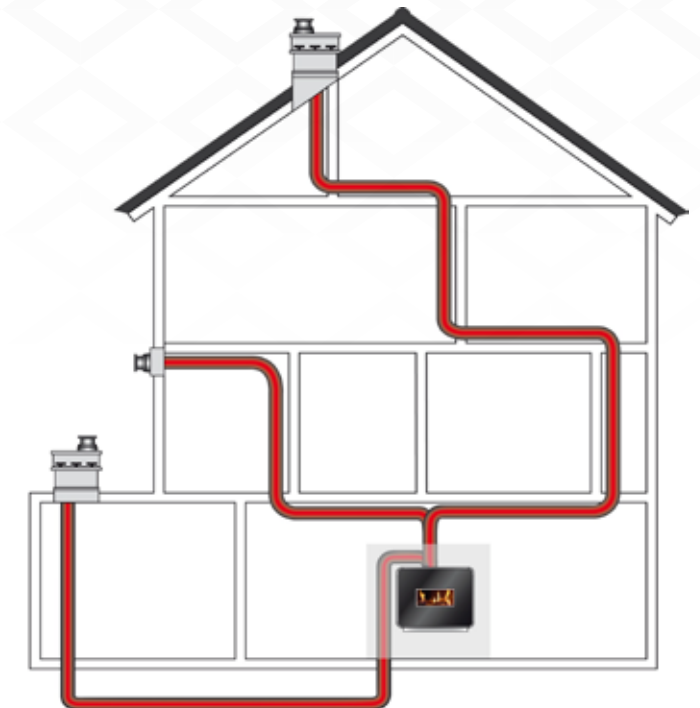

Via the roof, outside wall or crawl space  
• fan flue

### No chimney required



Via the roof (flat)  
• straight or with bends



Via roof (pitched)  
• straight or with bends



Via wall  
• directly on the fire with a 90° bend to the outside  
• possibly on a large part of the range



Via wall  
• first 1 meter vertically, then a 90° bend



Scan this QR code.





designed to be different

# FIRE AND CRAFT- MANSHIP SINCE 1754

*What's more comforting than a burning fireplace? Whether you have classic tastes or like clean lines, at DRU you will find the gas fire that suits you perfectly.*

Thanks to our knowledge and expertise - we have over 265 years of experience when it comes to comfortable, durable and safe warmth at home - we always offer you the best solution. Our innovative craftsmanship can be found in every model within our range of modern gas fires. These all meet very strict requirements when it comes to durability, efficiency, emissions, safety and ease of use, because we continue to improve ourselves, year after year. If you are looking for atmospheric warmth, then choose DRU.



#### THE BALANCE BETWEEN PEOPLE AND ENVIRONMENT

Sustainable business operations require a continuous balance between people and the environment. At DRU, customer satisfaction and efficiency go hand in hand with environmental friendliness and safety.



#### HIGH QUALITY AMBITION

We say what we do and do what we say. It's an ambitious and critical attitude that is perceptible everywhere and drives us to do a little better every day.



#### THE EASE OF USE THAT MAKES A DIFFERENCE

Ease of use for our customers is always at the heart of what we do and think. How can our products and services be smarter, more innovative, more satisfying? To keep these in mind we are in constant contact with users, suppliers and our dealers.



#### ONGOING DEVELOPMENT

Critical, curious, eager to learn, open to feedback, always wanting to do better. A progressive feeling that is anchored in our DNA. It is the awareness that we can only move forward by continuing to develop ourselves.



## LINE DRAWINGS

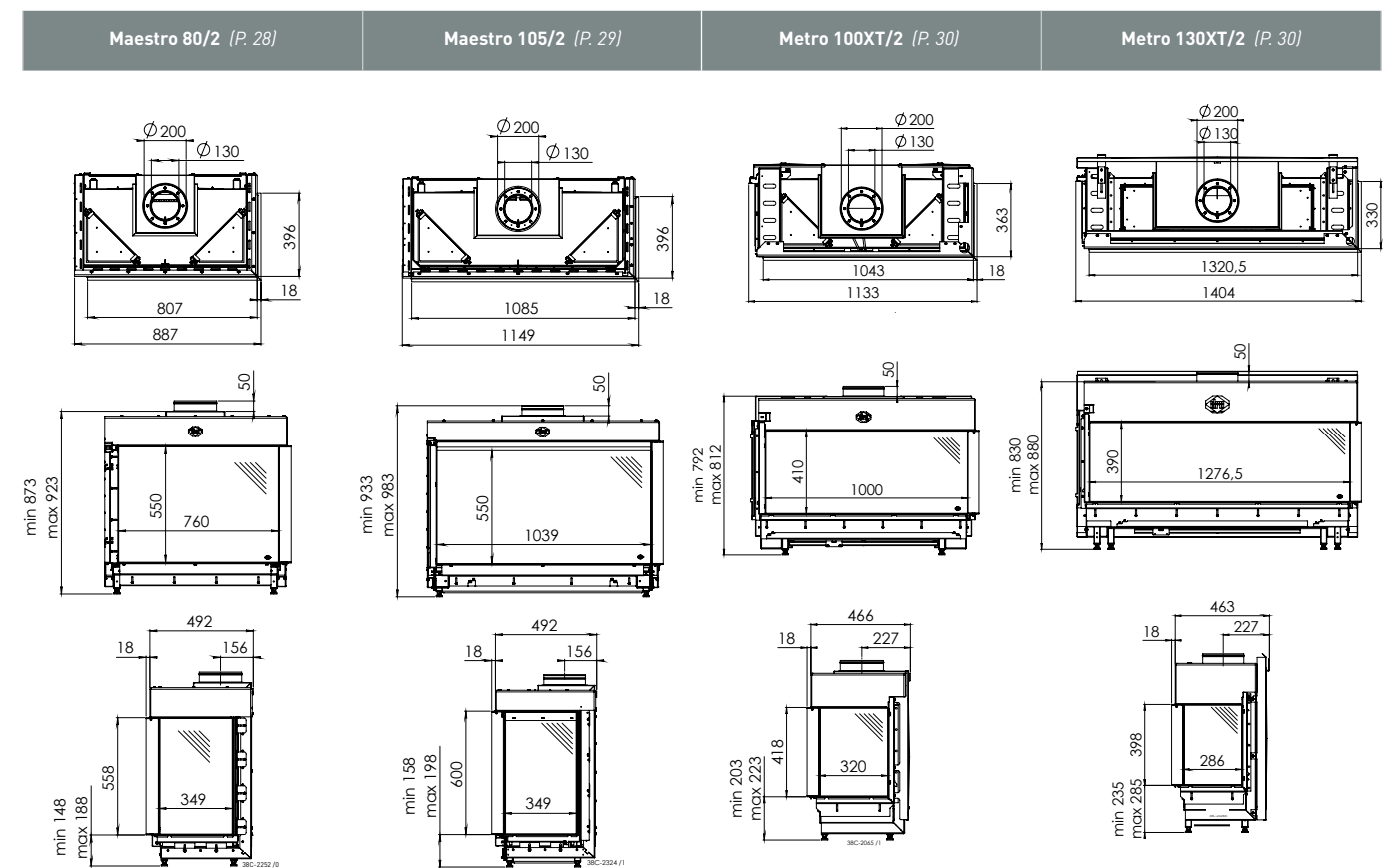
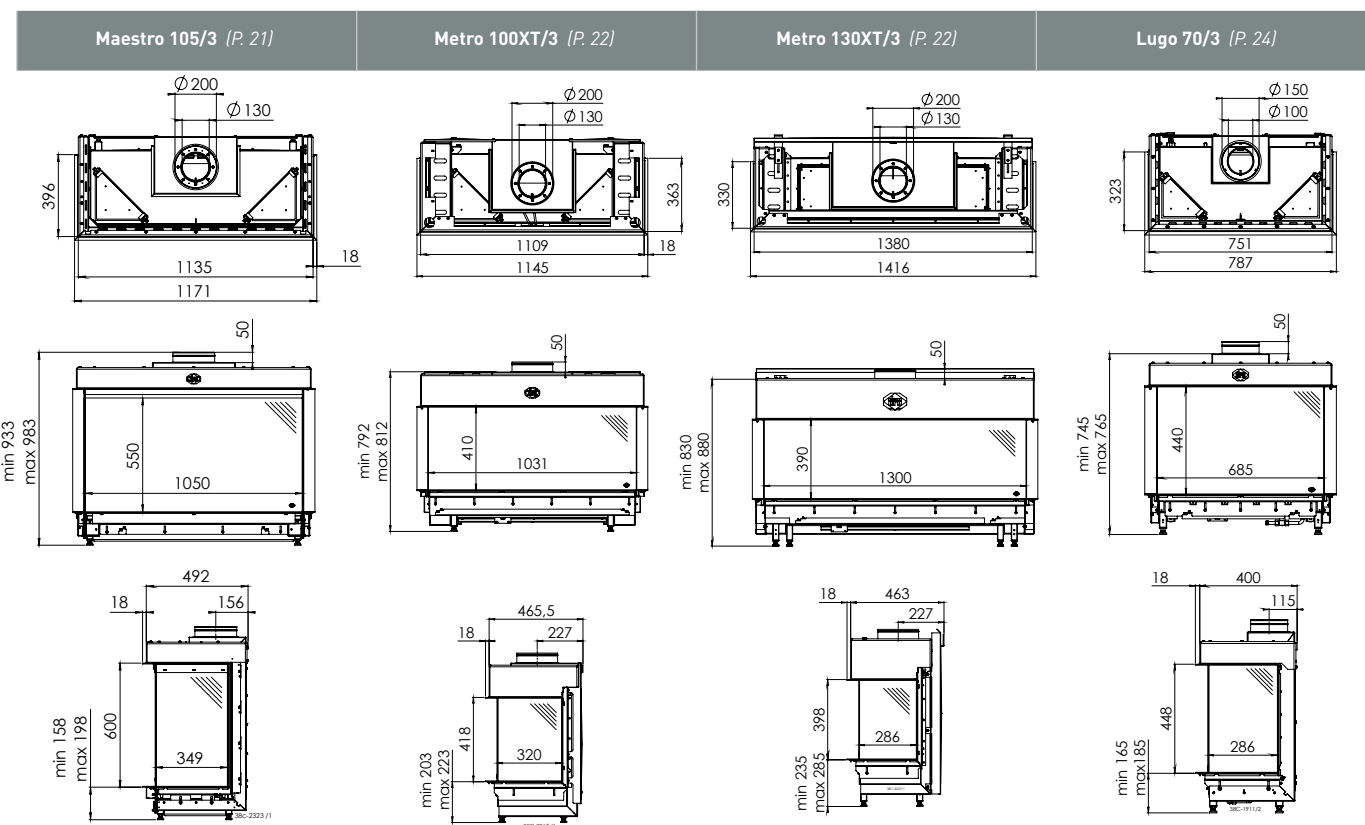
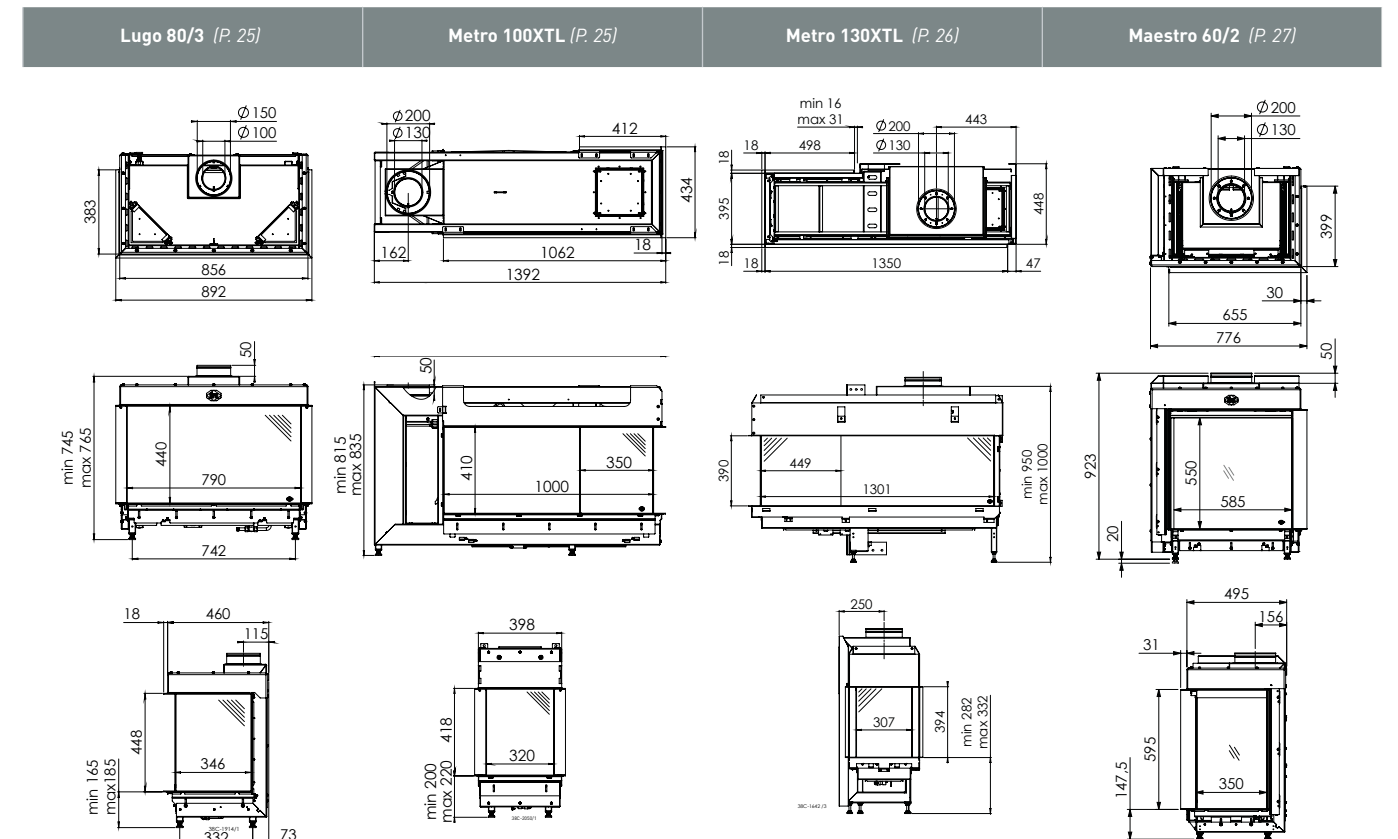
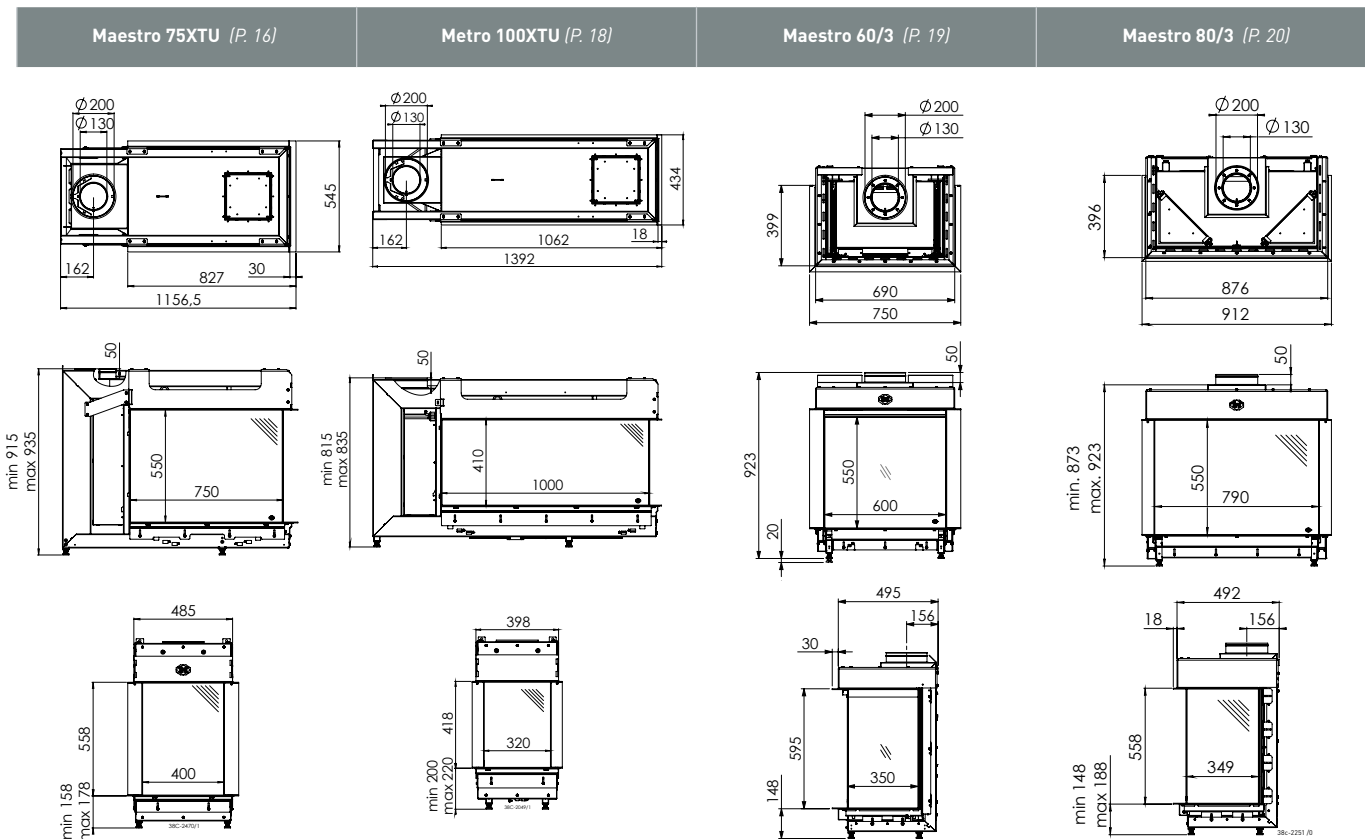



# LINE DRAWINGS

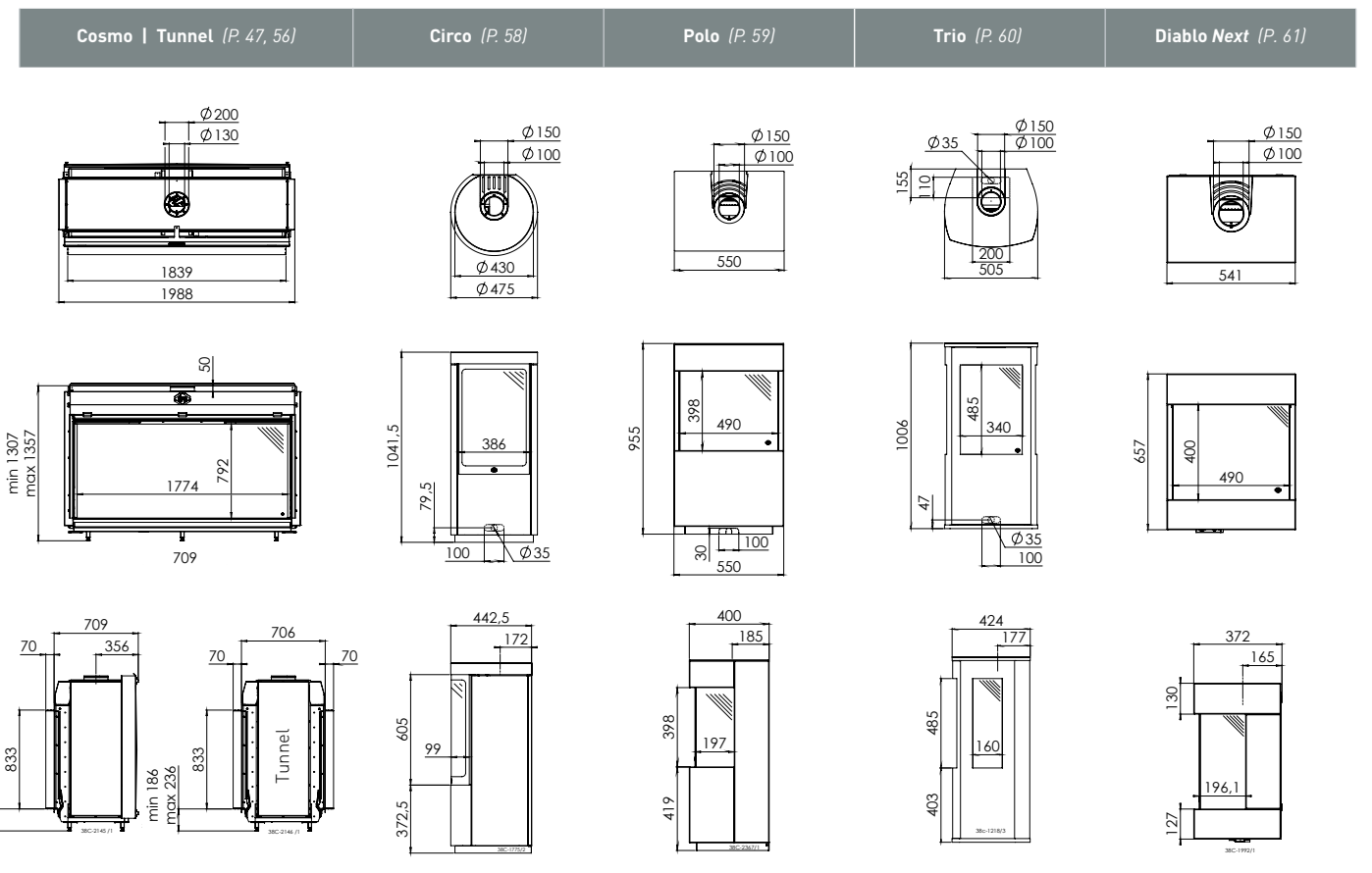
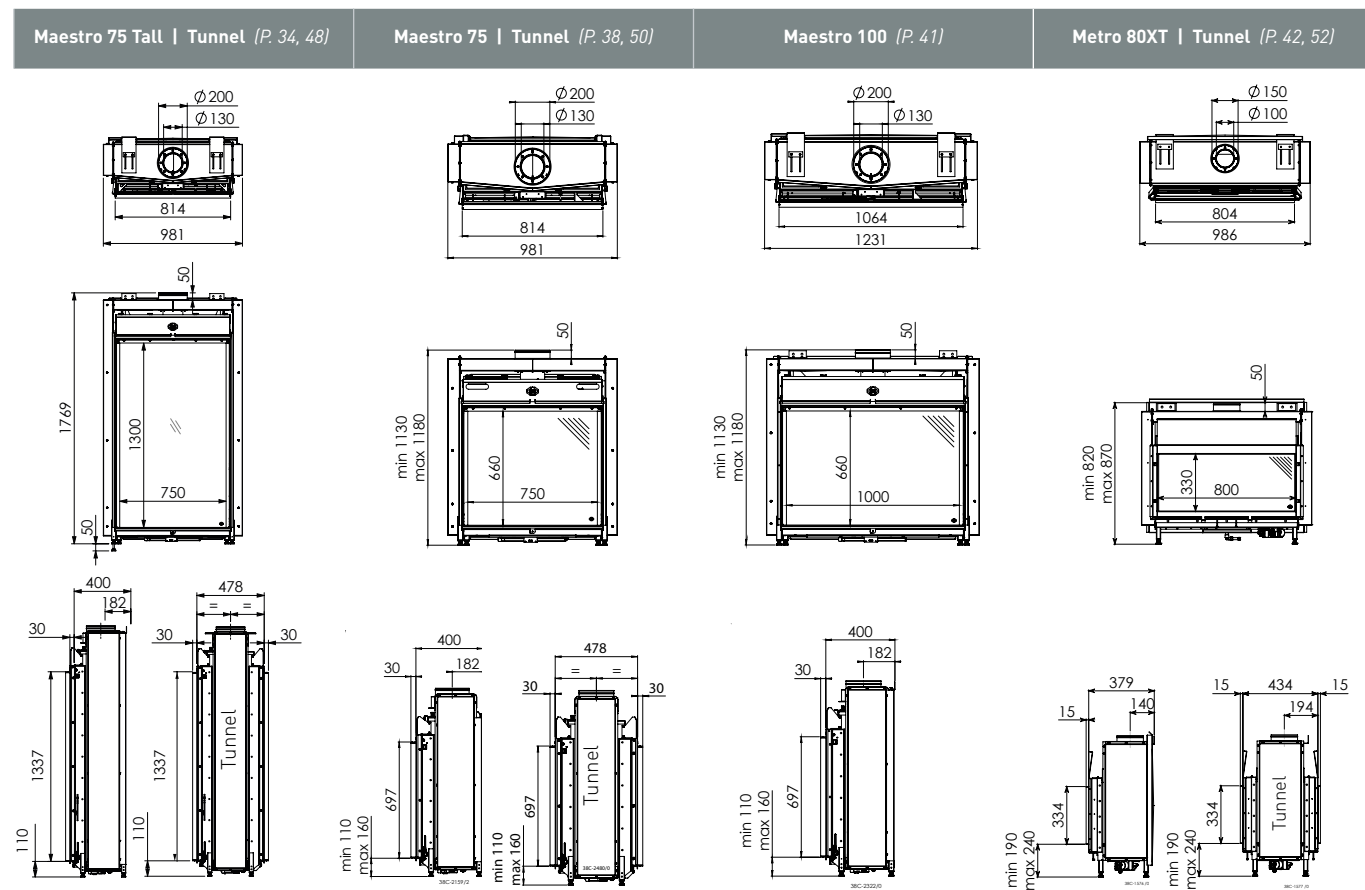
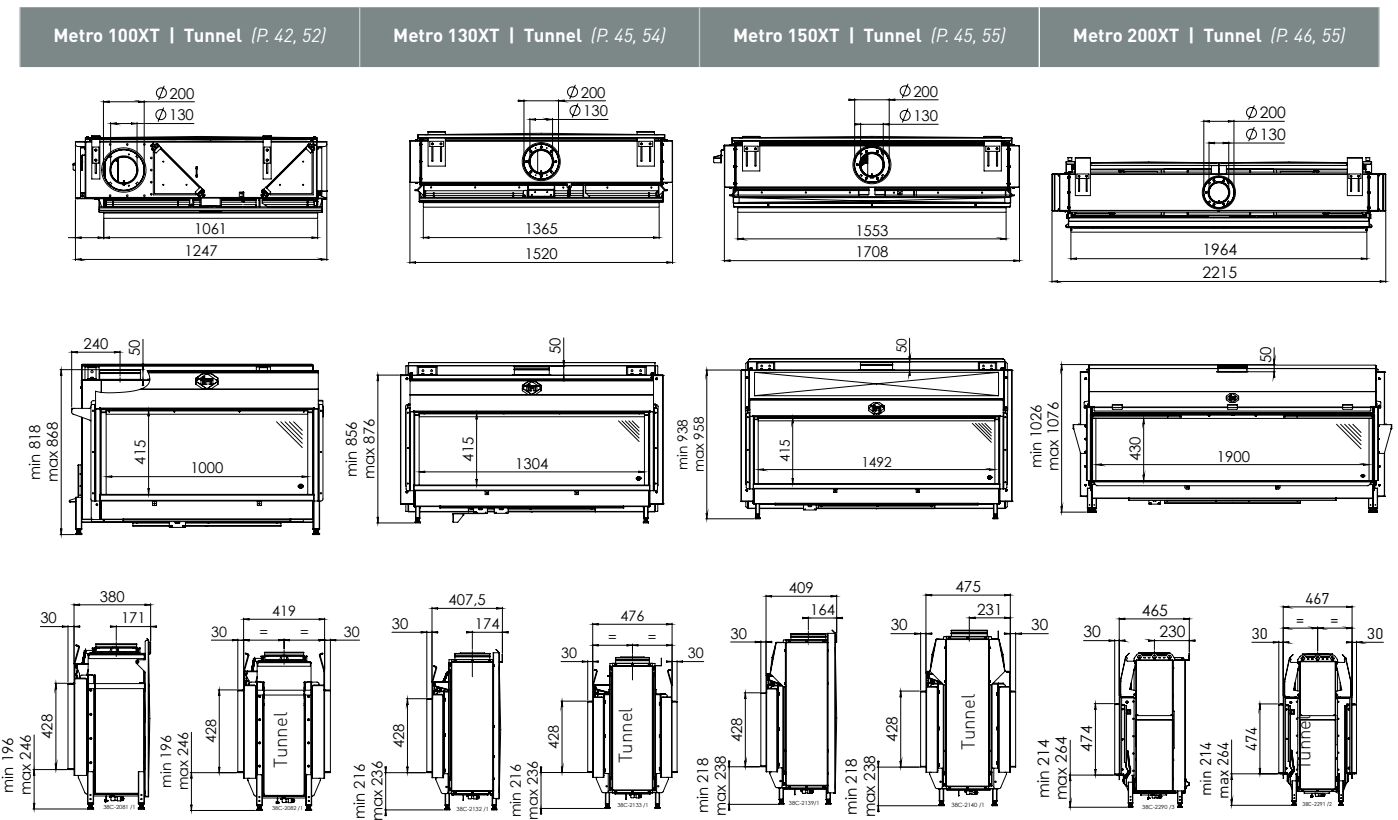
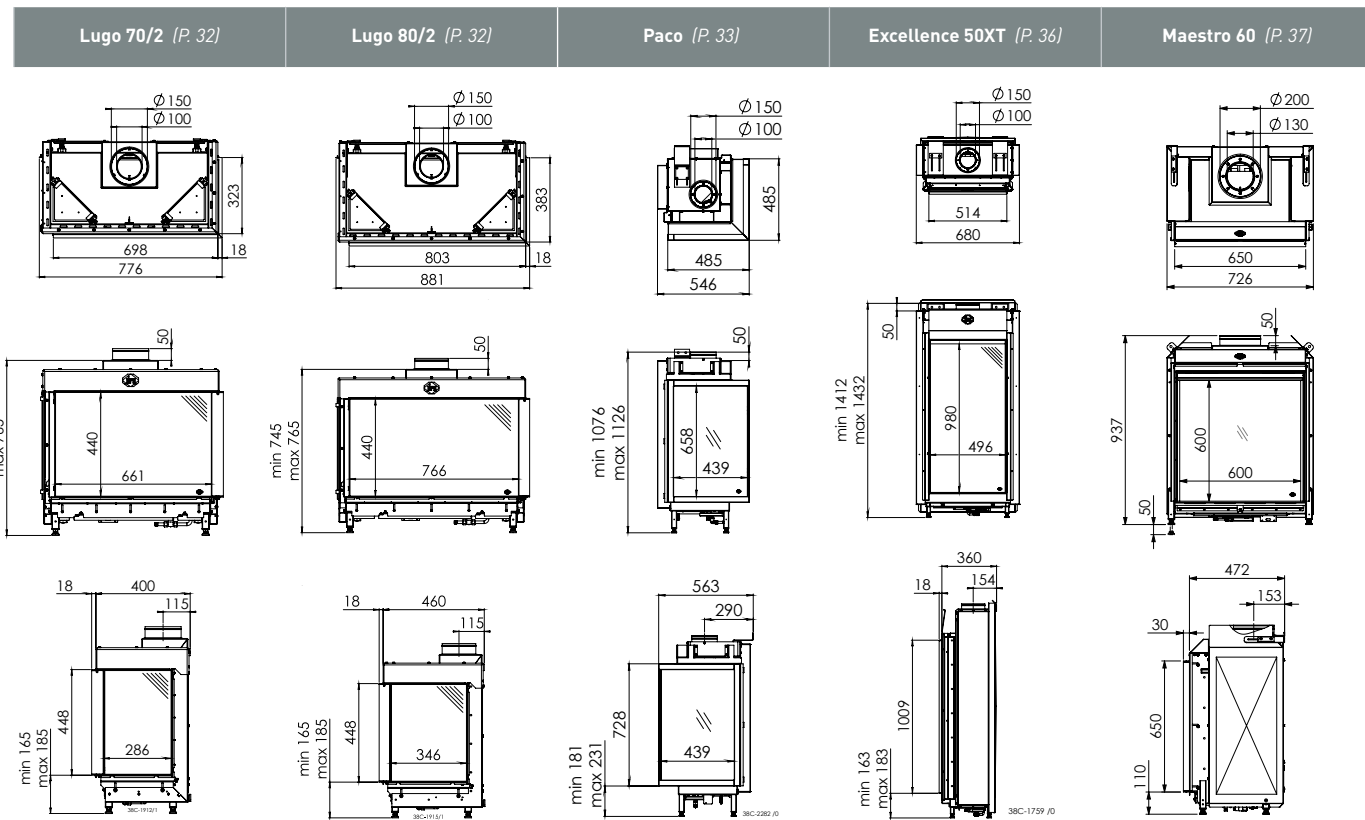



## LINE DRAWINGS

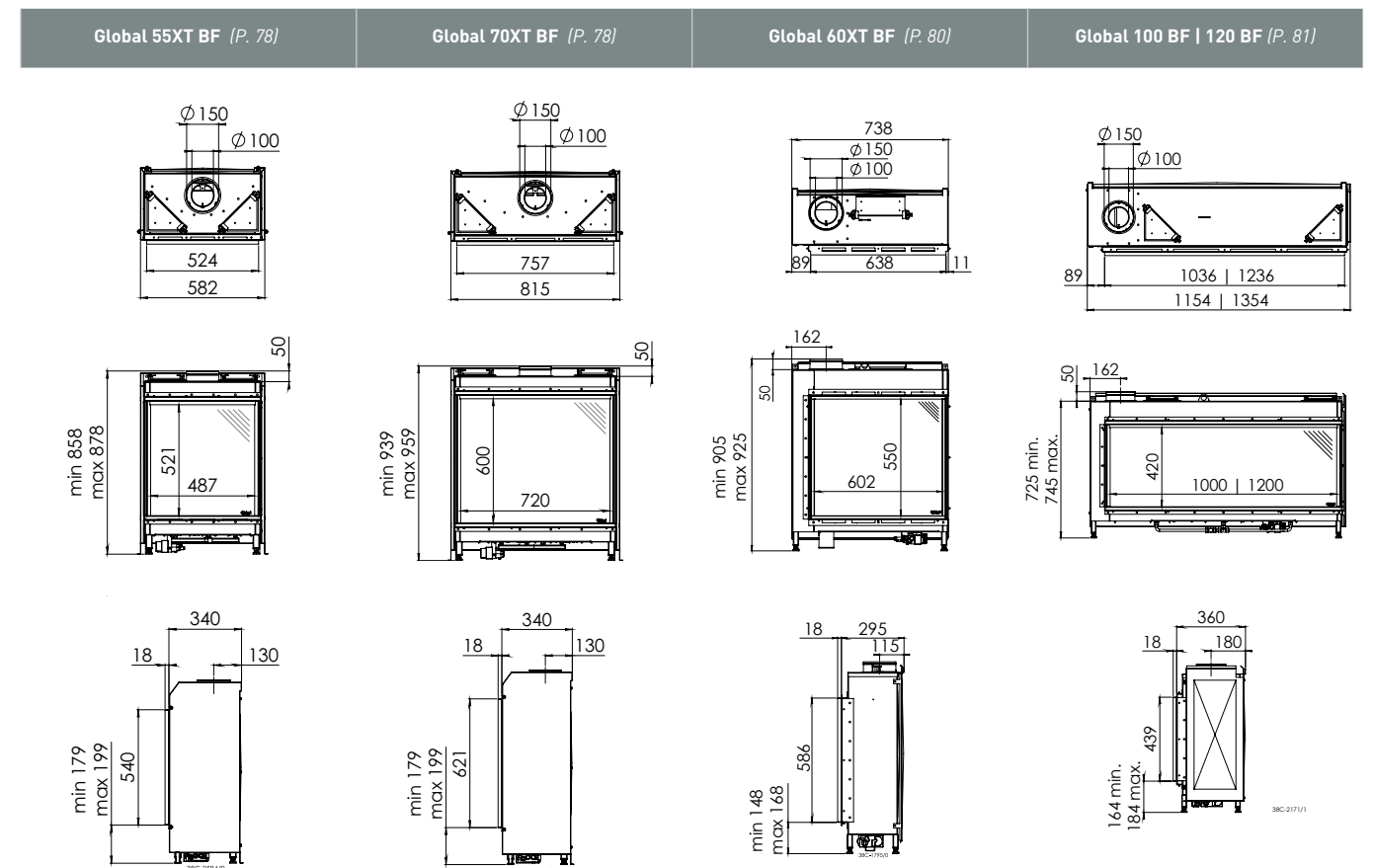
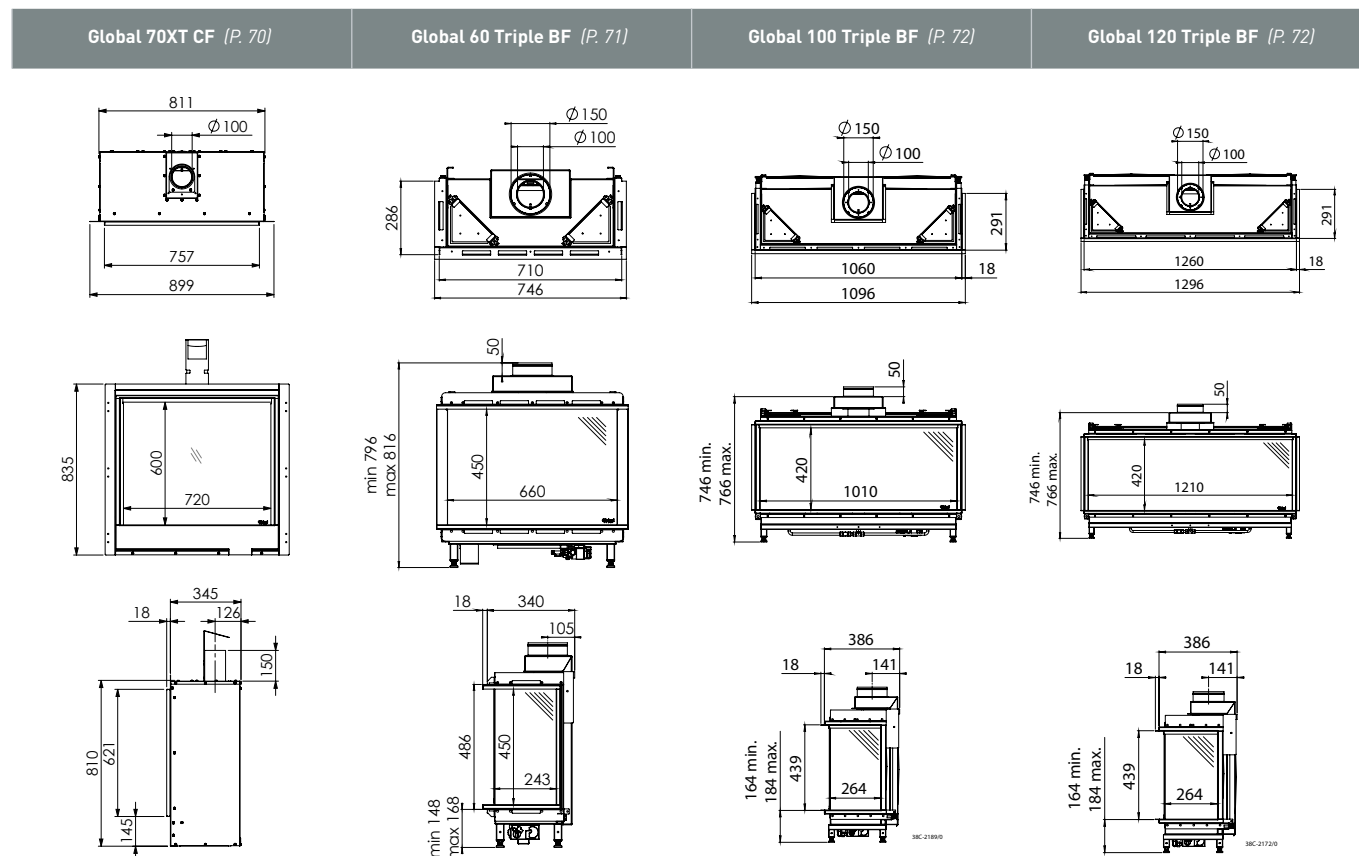
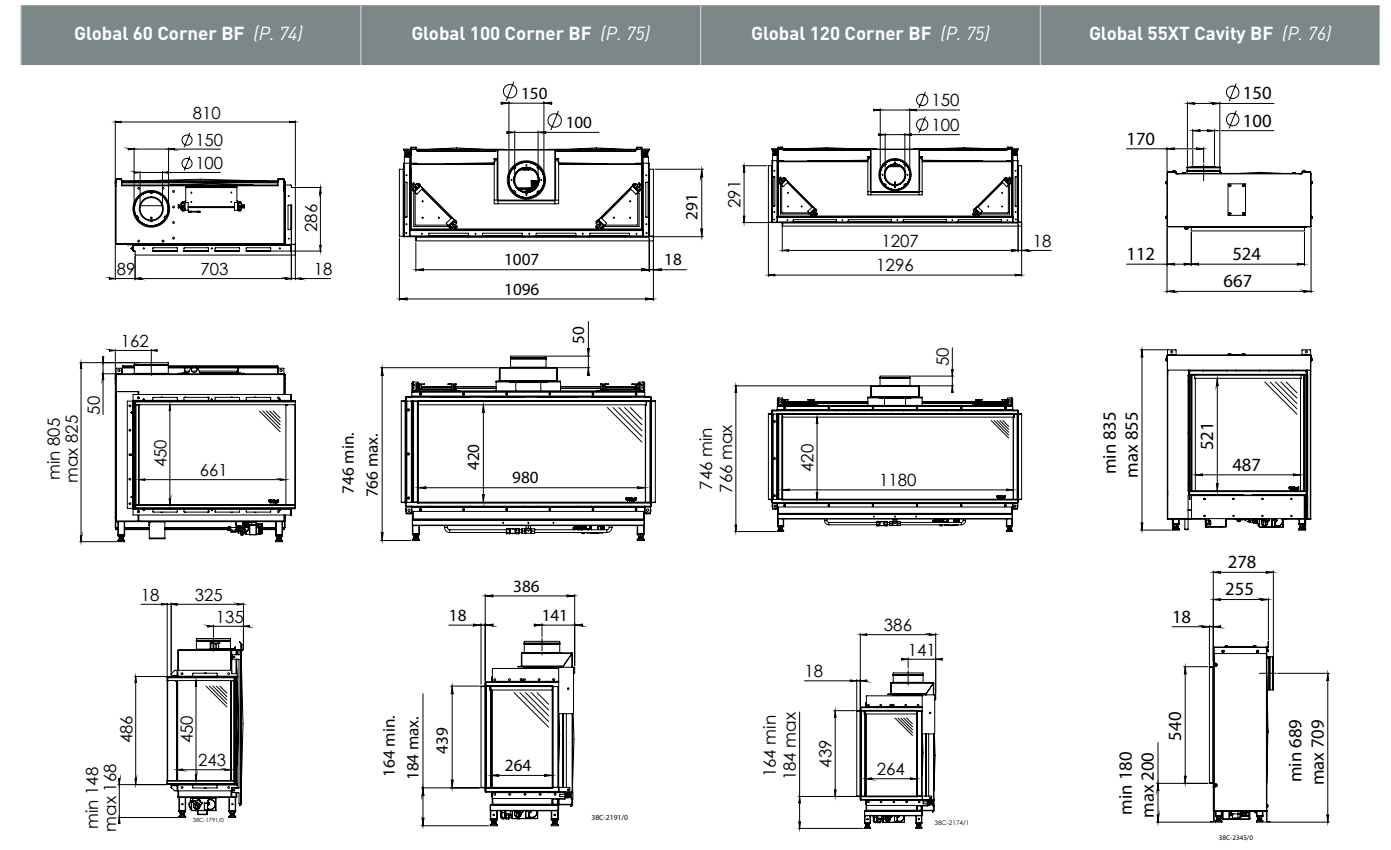
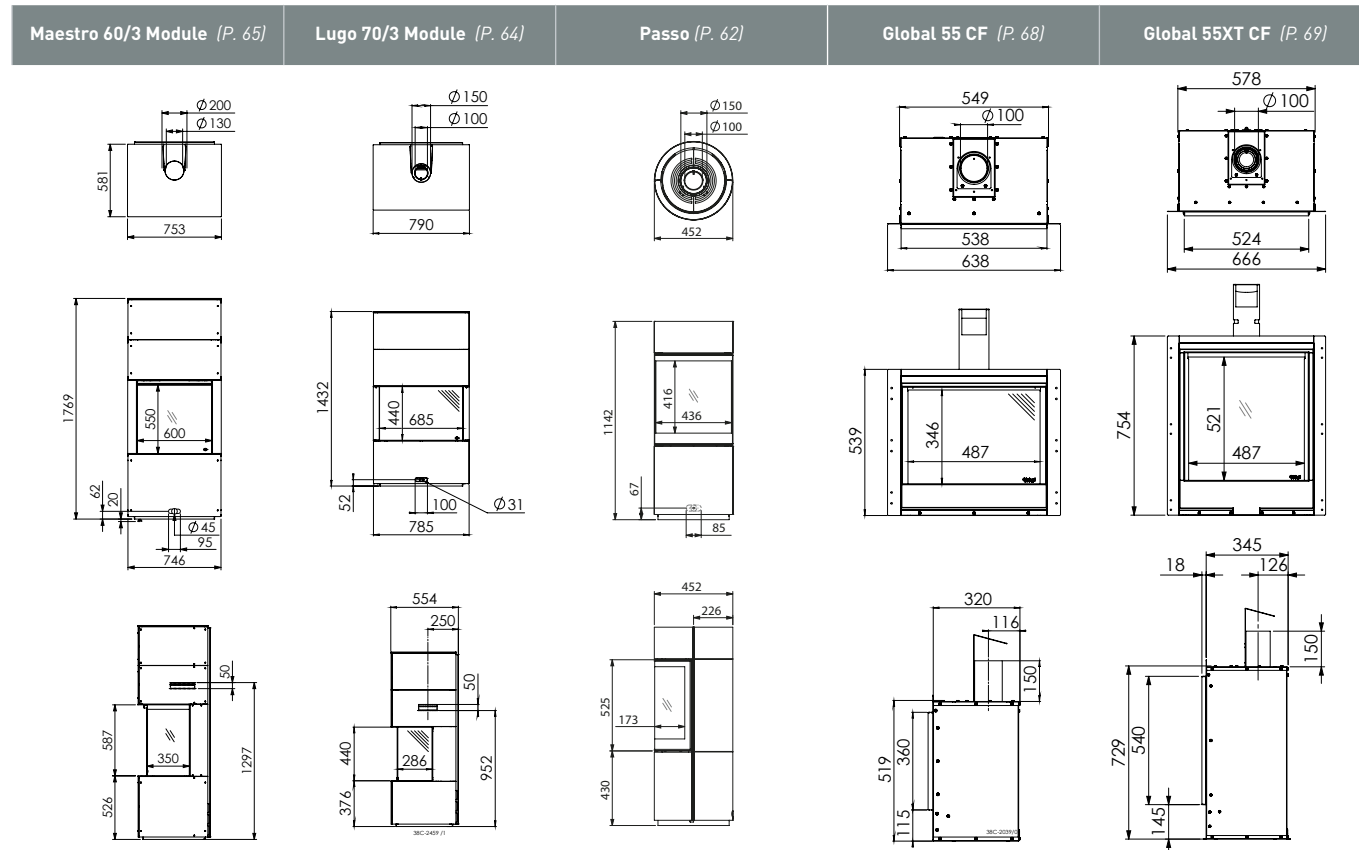





## TECHNICAL SPECIFICATIONS

DRU GAS FIRES	Page	Net capacity kW			Efficiency			Duct Ø	Built-in depth	Control hatch [P.82]		Remote control [P.82]	Weight	Eco Wave [P.7]		Easy release door system [P.12]		PowerVent® [P.86]		Clear View glass [P.12]		Interior finish [P.11]		Burner [P.8]		Burner bed [P.10]		
		Natural gas G20	Natural gas G25.3 (NL)	Propane G31	(%) G20	Natural gas G20	Natural gas G25.3			Propane G31	RCE			RCH	(kg)	Option	Black	Ceraglass	Natural	Classic stone	Type	Log set brown	Log set white	Stones white	Stones grey	Glass anthracite		
<b>3-SIDED FIRES (closed combustion)</b>																												
Maestro 75XTU Eco Wave	16	1,2 - 8,8	1,2 - 8,4	1,9 - 9,5	93,3	A	A	A	200/130	545	+	-	+	145	+	-	+	+	+	+	-	-	Dynamic Flame Burner®	+	-	-	-	-
Metro 100XTU Eco Wave	18	4,3 - 9,6	3,3 - 9,0	4,1 - 9,1	83,3	B	B	B	200/130	434	+	-	+	145	+	-	+	+	+	+	-	-	Vario Burner	+	-	+	-	+
Maestro 60/3 Eco Wave	19	1,9 - 7,2	1,6 - 6,8	1,1 - 7,3	94,3	A	A	A	200/130	495	+	-	+	130	+	+	+	+	+	+	-	-	Dynamic Flame Burner®	+	-	-	-	-
Maestro 80/3 Eco Wave	20	1,4 - 9,0	1,3 - 8,6	1,4 - 7,8	93,0	A	A	A	200/130	492	+	-	+	100	+	-	+	+	+	+	-	-	Dynamic Flame Burner®	+	-	-	-	-
Maestro 105/3 Eco Wave	21	2,2 - 9,3	1,8 - 8,7	1,5 - 9,6	87,5	B	A	A	200/130	492	+	-	+	120	+	+	+	+	+	+	-	-	Dynamic Flame Burner®	+	-	-	-	-
Metro 100XT/3 Eco Wave	22	4,3 - 9,6	3,3 - 9,0	4,1 - 9,1	83,3	B	B	B	200/130	466	+	-	+	145	+	-	+	+	+	+	-	-	Vario Burner	+	-	+	-	+
Metro 130XT/3 Eco Wave	23	5,1 - 10,8	4,1 - 10,2	5,6 - 10,6	89,6	A	A	A	200/130	463	+	-	+	160	+	-	+	+	+	+	-	-	Vario Burner	+	+	+	+	-
Lugo 70/3 Eco Wave	24	3,4 - 6,9	2,8 - 6,5	3,2 - 6,3	91,0	A	A	A	150/100	400	-	-	+	85	+	-	+	-	+	+	-	-	Vario Burner	+	-	-	-	-
Lugo 80/3 Eco Wave	25	3,4 - 6,9	2,8 - 6,5	3,2 - 6,3	91,0	A	A	A	150/100	460	-	-	+	96	+	-	+	-	+	+	-	-	Vario Burner	+	-	-	-	-
Metro 100XTL Eco Wave	26	4,3 - 9,6	3,3 - 9,0	4,1 - 9,1	83,3	B	B	B	200/130	434	+	-	+	145	+	-	+	+	+	+	-	-	Vario Burner	+	-	+	-	+
Metro 130XTL Eco Wave	26	5,1 - 10,8	4,1 - 10,2	5,6 - 10,6	89,6	A	A	A	200/130	448	+	-	+	160	+	-	+	+	+	+	-	-	Vario Burner	+	+	+	+	-
<b>2-SIDED FIRES (closed combustion)</b>																												
Maestro 60/2 Eco Wave	27	1,9 - 7,2	1,6 - 6,8	1,1 - 7,3	94,3	A	A	A	200/130	495	+	-	+	130	+	+	+	+	+	+	-	-	Dynamic Flame Burner®	+	-	-	-	-
Maestro 80/2 Eco Wave	28	1,4 - 9,0	1,3 - 8,6	1,4 - 7,8	93,0	A	A	A	200/130	492	+	-	+	100	+	-	+	+	+	+	-	-	Dynamic Flame Burner®	+	-	-	-	-
Maestro 105/2 Eco Wave	29	2,2 - 9,3	1,8 - 8,7	1,5 - 9,6	87,5	B	A	A	200/130	492	+	-	+	120	+	+	+	+	+	+	-	-	Dynamic Flame Burner®	+	-	-	-	+
Metro 100XT/2 Eco Wave	31	4,3 - 9,6	3,3 - 9,0	4,1 - 9,1	83,3	B	B	B	200/130	466	+	-	+	160	+	-	+	+	+	+	-	-	Vario Burner	+	-	+	-	-
Metro 130XT/2 Eco Wave	31	5,1 - 10,8	4,1 - 10,2	5,6 - 10,6	89,6	A	A	A	200/130	466	+	-	+	160	+	-	+	+	+	+	-	-	Vario Burner	+	+	+	+	-
Lugo 70/2 Eco Wave	32	3,4 - 6,9	2,8 - 6,5	3,2 - 6,3	91,0	A	A	A	150/100	400	-	-	+	85	+	-	+	-	+	+	-	-	Vario Burner	+	-	-	-	-
Lugo 80/2 Eco Wave	32	3,4 - 6,9	2,8 - 6,5	3,2 - 6,3	91,0	A	A	A	150/100	460	-	-	+	96	+	-	+	-	+	+	-	-	Vario Burner	+	-	-	-	-
Paco Eco Wave	33	2,6 - 5,4	2,1 - 5,0	-	84,8	B	C	-	150/100	563	+	-	+	70	+	-	+	-	-	+	-	-	Line Burner	+	-	-	-	-
<b>FRONT FIRES (closed combustion)</b>																												
Maestro 75 Tall Eco Wave	34	1,7 - 9,2	1,5 - 8,7	1,5 - 8,2	91,6	A	A	A	200/130	400	+	-	+	200	+	+	+	+	+	-	+	-	Dynamic Flame Burner®	+	-	-	-	-
Excellence 50XT Eco Wave	36	2,3 - 7,9	1,9 - 7,5	-	87,0	B	B	-	150/100	360	+	-	+	120	+	-	+	+	+	-	+	-	Line Burner	+	-	-	-	-
Maestro 60 Eco Wave	37	1,9 - 7,2	1,6 - 6,8	1,1 - 7,3	94,3	A	A	A	200/130	472	+	-	+	130	+	+	+	+	+	+	-	+	Dynamic Flame Burner®	+	-	-	-	-
Maestro 75 Eco Wave	39	1,3 - 9,0	1,2 - 8,6	1,3 - 7,4	89,0	A	A	A	200/130	400	+	-	+	80	+	+	+	+	+	+	-	+	Dynamic Flame Burner®	+	-	-	-	-
Maestro 100 Eco Wave	41	2,3 - 10,0	1,9 - 9,3	2,3 - 10,2	92,1	A	A	A	200/130	400	+	-	+	100	+	+	+	+	+	+	-	+	Dynamic Flame Burner®	+	-	-	-	-
Metro 80XT Eco Wave	43	3,0 - 5,4	2,3 - 5,1	2,8 - 5,7	88,9	A	B	A	150/100	379	+	-	+	88	+	-	+	+	+	+	-	-	Vario Burner	+	-	+	-	-
Metro 100XT Eco Wave	43	4,3 - 9,6	3,3 - 9,0	4,1 - 9,1	83,3	B	B	B	200/130	380	+	-	+	145	+	+	+	+	+	+	-	-	Vario Burner	+	-	+	-	+
Metro 130XT Eco Wave	45	5,1 - 10,8	4,1 - 10,2	5,6 - 10,6	89,6	A	A	A	200/130	408	+	-	+	160	+	+	+	+	+	+	-	-	Vario Burner	+	+	+	+	-
Metro 150XT Eco Wave	45	5,9 - 10,8	4,9 - 10,3	5,3 - 11,1	87,9	A	A	A	200/130	409	+	-	+	160	+	+	+	+	+	-	+	-	Vario Burner	+	+	+	+	-
Metro 200XT Eco Wave	46	8,9 - 16,7	7,2 - 15,8	-	90,3	A	A	-	200/130	465	+	-	+	265	+	+	+	+	+	-	+	-	Vario Burner	+	-	+	-	+
Cosmo Eco Wave	47	6,0 - 16,3	4,9 - 15,7	-	89,3	A	A	-	200/130	709	+	-	+	350	+	+	+	+	+	+	-	+	Vario Burner	+	-	-	-	-
<b>TUNNEL FIRES (closed combustion)</b>																												
Maestro 75 Tall Tunnel Eco Wave	48	2,0 - 10,2	1,7 - 9,5	2,0 - 10,0	92,0	A	A	A	200/130	478	+	-	+	218	+	+	+	+	+	+	-	-	Dynamic Flame Burner®	+	-	-	-	-
Maestro 75 Tunnel Eco Wave	50	1,7 - 9,1	1,5 - 8,5	1,9 - 9,5	93,0	A	A	A	200/130	478	+	-	+	160	+	+	+	+	+	+	-	-	Dynamic Flame Burner®	+	-	-	-	-
Metro 80XT Tunnel Eco Wave	52	3,0 - 5,4	2,3 - 5,1	2,8 - 5,7	88,9	A	B	A	150/100	434	+	-	+	96	+	-	+	+	+	+	-	-	Vario Burner	+	-	+	-	-
Metro 100XT Tunnel Eco Wave	52	4,3 - 9,6	3,3 - 9,0	4,1 - 9,1	83,3	B	B	B	200/130	419	+	-	+	145	+	+	+	+	+	+	-	-	Vario Burner	+	-	+	-	+
Metro 130XT Tunnel Eco Wave	54	5,1 - 10,8	4,1 - 10,2	5,6 - 10,6	89,6	A	A	A	200/130	476	+	-	+	160	+	+	+	+	+	+	-	-	Vario Burner	+	+	+	+	-
Metro 150XT Tunnel Eco Wave	55	5,9 - 10,8	4,9 - 10,3	5,3 - 11,1	87,9	A	A	A	200/130	475	+	-	+	160	+	+	+	+	+	+	-	-	Vario Burner	+	+	+	+	-
Metro 200XT Tunnel Eco Wave	55	8,9 - 16,7	7,2 - 15,8	-	90,3	A	A	-	200/130	467	+	-	+	265	+	+	+	+	+	+	-	-	Vario Burner	+	-	+	-	+
Cosmo Tunnel Eco Wave	56	6,0 - 16,3	4,9 - 15,7	-	89,3	A	A	-	200/130	706	+	-	+	350	+	+	+	+	+	+	-	-	Vario Burner	+	-	-	-	-

## TECHNICAL SPECIFICATIONS

DRU GAS FIRES		Page	Net capacity kW			Efficiency			Duct Ø	Built-in depth	Control hatch [P.82]		Remote control [P.82]	Weight	Eco Wave [P.7]		Easy release door system [P.12]		PowerVent® [P.86]		Clear View glass [P.12]		Interior finish [P.11]		Burner [P.8]		Burner bed [P.10]		
			Natural gas G20	Natural gas G25.3 (NL)	Propane G31	(%) G20	Natural gas G20	Natural gas G25.3			Propane G31	(mm)			(mm)	RCE	RCH	(kg)	Option	Black	Ceraglass	Natural	Classic stone	Type	Log set brown	Log set white	Stones white	Stones grey	Glass anthracite
<b>FREESTANDING FIRES (closed combustion)</b>																													
Circo	58	2,9 - 7,0	2,7 - 6,0	2,8 - 6,2	92,5	A	A	A	150/100	442	-	+	-	110	-	-	-	-	+	-	-	-	-	Line Burner	+	-	-	-	-
Polo	59	1,6 - 4,1	1,5 - 3,8	1,6 - 3,8	92,6	A	A	A	150/100	400	-	+	-	68	-	-	-	-	+	+	-	-	-	Line Burner	+	-	-	-	-
Trio	60	2,0 - 4,5	1,8 - 4,2	1,5 - 4,0	85,4	B	B	C	150/100	441	-	+	-	80	-	-	-	-	+	-	-	-	-	Line Burner	+	-	-	-	-
Diablo Next	61	1,6 - 4,1	1,5 - 3,8	1,6 - 3,8	92,6	A	A	A	150/100	372	-	+	-	48	-	-	-	-	+	+	-	-	-	Line Burner	+	-	-	-	-
Lugo 70/3 Module Eco Wave	64	3,4 - 6,9	2,8 - 6,5	3,2 - 6,3	91,0	A	A	A	150/100	554	-	-	+	85	+	-	-	-	+	+	-	-	-	Vario Burner	+	-	-	-	-
Maestro 60/3 Module Eco Wave	65	1,9 - 7,2	1,6 - 6,8	1,1 - 7,3	94,3	A	A	A	200/130	581	-	-	+	160	+	+	-	+	+	+	-	-	-	Dynamic Flame Burner®	+	-	-	-	-
Passo Eco Wave	62	1,2 - 6,4	0,9 - 6,1	-	93,0	A	A	-	150/100	452	-	-	+	95	+	+	-	-	+	-	-	-	-	Dynamic Flame Burner®	+	-	-	-	-

GLOBAL BY DRU GAS FIRES		Page	Net capacity kW			Efficiency			Duct Ø	Built-in depth	Control hatch P.82		Remote control [P.82]	Weight	Eco Wave [P.7]		Easy release door system [P.12]		PowerVent® [P.86]		Clear View glass [P.12]		Interior finish [P.11]		Burner [P.8]		Burner bed P.10		
			Natural gas G20	Natural gas G25.3 (NL)	Propane G31	(%) G20	Natural gas G20	Natural gas G25.3			Propane G31	(mm)			(mm)	RCE	RCH	(kg)	Option	Black	Ceraglass	Natural	Classic stone	Type	Log set brown	Log set white	Stones white	Stones grey	Glass anthracite
<b>FRONT FIRES (open combustion)</b>																													
Global 55 CF	68	1,9 - 3,9	1,5 - 3,7	1,9 - 4,0	77,7	C	C	C	100	320	-	+	-	43	-	-	-	-	+	+	-	+	-	Line Burner	+	-	-	-	-
Global 55XT CF	69	2,8 - 3,7	2,6 - 3,5	-	74,4	D	D	-	100	345	-	+	-	43	-	-	-	+	+	+	-	+	-	Truflame Burner®	+	-	-	-	-
Global 70XT CF	70	3,1 - 4,5	2,7 - 4,4	4,0 - 4,6	77,1	C	D	D	100	345	-	+	-	63	-	-	-	+	+	+	-	+	-	Truflame Burner®	+	-	-	-	-
<b>3-SIDED FIRES (closed combustion)</b>																													
Global 60 Triple BF	71	2,3 - 6,0	2,1 - 5,4	3,0 - 6,2	91,5	A	A	A	150/100	340	-	+	-	65	-	-	-	-	+	+	-	-	-	Line Burner	+	-	+	-	-
Global 100 Triple BF	72	2,8 - 7,5	2,6 - 7,1	3,5 - 7,0	94,0	A	A	A	150/100	386	-	+	-	100	-	-	-	-	+	+	-	-	-	Line Burner	+	-	+	-	+
Global 120 Triple BF	73	2,8 - 7,5	2,6 - 7,1	3,5 - 7,0	94,0	A	A	A	150/100	386	-	+	-	120	-	-	-	-	+	+	-	-	-	Line Burner	+	-	+	-	+
<b>2-SIDED FIRES (closed combustion)</b>																													
Global 60 Corner BF	74	2,3 - 6,0	2,1 - 5,4	3,0 - 6,2	91,5	A	A	A	150/100	325	-	+	-	62	-	-	-	-	+	+	-	-	-	Line Burner	+	-	+	-	-
Global 100 Corner BF	75	2,8 - 7,5	2,6 - 7,1	3,5 - 7,0	94,0	A	A	A	150/100	386	-	+	-	100	-	-	-	-	+	+	-	-	-	Line Burner	+	-	+	-	+
Global 120 Corner BF	75	2,8 - 7,5	2,6 - 7,1	3,5 - 7,0	94,0	A	A	A	150/100	386	-	+	-	120	-	-	-	-	+	+	-	-	-	Line Burner	+	-	+	-	+
<b>FRONT FIRES (closed combustion)</b>																													
Global 55XT Cavity BF (UK only)	76	1,8 - 3,2	-	-	77,4	C	-	-	150/100	255	-	+	-	40	-	-	-	+	-	+	-	-	-	Truflame Burner®	+	-	-	-	-
Global 55XT BF	78	2,6 - 4,6	2,4 - 4,3	3,1 - 4,4	77,4	A	A	A	150/100	340	-	+	-	90	-	-	-	+	+	+	-	+	-	Truflame Burner®	+	-	-	-	-
Global 70XT BF	78	3,4 - 5,7	3,1 - 5,3	3,2 - 5,5	92,7	A	A	A	150/100	340	-	+	-	103	-	-	-	+	+	+	-	+	-	Truflame Burner®	+	-	-	-	-
Global 60XT BF	80	2,5 - 6,5	2,3 - 6,0	3,3 - 6,8	91,9	A	A	A	150/100	295	-	+	-	61	-	-	-	-	+	+	-	-	-	Line Burner	+	-	+	-	-
Global 100 BF	81	2,8 - 7,5	2,6 - 7,1	3,5 - 7,0	94,0	A	A	A	150/100	290	-	+	-	75	-	-	-	-	+	+	-	-	-	Line Burner	+	-	+	-	+
Global 120 BF	81	2,8 - 7,5	2,6 - 7,1	3,5 - 7,0	94,0	A	A	A	150/100	360	-	+	-	120	-	-	-	-	+	+	-	-	-	Line Burner	+	-	+	-	+

LPG - Due to the nature of LPG, Log sets and Flame effects can differ from NG fires - Please consult your dealer.





DRU Verwarming B.V.  
 P.O. Box 1021 | 6920 BA Duiven  
 Ratio 8 | 6921 RW Duiven  
 The Netherlands  
 T. +31 (0)26 - 319 5 319  
 F. +31 (0)26 - 319 5 348  
 www.dru.nl

Drugasar Ltd.  
 Deans Road | Swinton  
 Manchester | M27 0JH  
 United Kingdom  
 T. +44 (0)161 - 793 8700  
 F. +44 (0)161 - 727 8057  
 www.drufire.co.uk

DRU Belgium  
 Kontichsesteenweg 69/1  
 2630 Aartselaar  
 Belgium  
 T. +32 (0)3 - 450 7000  
 F. +32 (0)3 - 450 7009  
 www.drufire.be

Dealer



www.drufire.com



BY APPOINTMENT OF  
 THE COURT OF THE NETHERLANDS

since  
**1754**



DRU: Member of the Spartherm-Group

Subject to changes. The colours in this brochure may vary from the actual products. Nothing in this publication may be used without prior written consent from DRU Verwarming B.V.